

## Numerical Simulation Based on Transfer Function Specific to Proliferation of Tumor Cell Lines

CORINA C. BRINDUSA<sup>1</sup>, PHILIPPE DONDON<sup>2</sup>, CORNELIA A. BULUCEA<sup>3</sup>

<sup>1</sup>Faculty of Medicine, University of Medicine and Pharmacy Craiova, Romania,  
corinaa\_b@yahoo.com

<sup>2</sup>University of Bordeaux, IPB ENSEIRB MATMECA, Av Dr. A. Schweitzer 33405 Talence, France,  
Philippe.Dondon@enseirb-matmeca.fr

<sup>3</sup>Faculty of Electrical Engineering, University of Craiova, Romania, abulucea@em.ucv.ro

*Abstract:* - Glioblastoma is the most common highest-grade and lethal type of brain tumor, causing a high rate of death each year worldwide. Given the resistance of this tumor to standard surgery, radiation and chemotherapy, the consistent efforts to comprehensively profile glioblastomas using latest technologies are addressing this need. In line with this idea, this paper focuses to enhancing understanding of the potentially useful correlations between medicine field, electrical engineering, mathematical modeling and numerical simulation, as parts of our knowledge about life, Nature and Universe. Analysis of variables specific to a biological system by type of tumor cell populations can be made by analogy with the electric structure of passive quadrupole type. The transfer function is determined directly through a complex electronic structures encompassing a *RC* (resistor, capacitance) quadrupole + operational amplifier *OA*. By evaluating *in vitro* of the cell line *GB9B*, derived from glioblastoma, (*GB*), and based on the analysis of residues is determined indirectly, and validates the transfer function. Mathematical model of transfer function type enables to simulate numerical *2D* of the expression of the output quantity. The findings of this work supports the belief in the power of science, demonstrating the strong links between the research in medicine field, and the electrical engineering outcomes.

*Key-Words:* cell fraction, electric passive quadrupole, mathematical modeling and numerical simulation, transfer function, tumor cells

### 1 Introduction

The high incidence of multiform glioblastoma cases and special aggressiveness of such brain tumors have led to a large number of research papers in this area.

Multiform Glioblastoma is the most common type of primary malignant brain tumours, with a mean survival / patient for about a year. The adverse prognosis could be explained by the glioblastoma resistance to various disturbing factors. A negative aspect in the post-operative evolution, namely the surgical removal of tumour tissue is given by a high rate of recurrence of the tumour. Causality of this aspect of tumour recurrence is unknown. It is believed that endogenous tumour cells are the source of new tumour cells [1].

The prognosis of patients with glioblastoma is extremely poor despite multimodal treatments including surgery, chemotherapy, radiotherapy [2].

For *in vivo* investigations, it is known that the explosive growth of tumors, including glioblastomas, is related to the formation of vascular

networks mimicry, (*VM*). Vascular networks remarkably contribute to the aggressiveness of cancer cells in the body, the appearance of fast growing tumors [3,4].

A number of studies emphasize the role of stem cells in tumor formation and development, including the formation of vascular networks mimicry, *VM*. So, the development of the tumor mass is accompanied by the appearance of their very intense vascular process [5,6,7].

In an analysis of cell lines derived from glioblastoma, *GB*, one could note that such cells do not show contact inhibition.

Also, such cells are resistant, in certain limits, to a number of perturbations that may occur in the biochemical cultivation process: they are less dependent on the absence of a continuous input of energy (can increase with fewer nutrients); are more resistant to temperature and *pH* shocks etc.

Cells derived from *GB* belong to the class of immortal cells, meaning they have theoretically the possibility to divide themselves indefinitely.

In literature we find models that describe the development of cell populations, rather we have models describing analytically the specific growth rate of the cell mass depending on the concentration of culture substrate  $S$ . A good correlation is offered by *Monod relationship*, expressing analytical dependence of the specific growth rate of cell mass, as a function of the concentration of the substrate. In situations where one of the components of the nutritious substrate starts to miss, developing of cell population is limited, a situation reflected by decreasing of specific growth rate of cell mass.

A mathematical model which expresses the way for the development of a tumor cell structures were developed by the Skipper and colleagues. Such a model is given by an expression that is based on exponential kinetics, [8]. In exponential growth the cell number  $N$  is a function of the starting size  $N(0)$ , the time of growth  $t$  and a constant  $b$  [8,9].

An Gompertzian model is sufficient to simulate clinical data, a high degree of confidence in the precision of the estimated parameters is neither meant nor justified. Such refinements as the inclusion of variable  $N(\infty)$ ,  $N_L$ , and  $N_R$  would seem to be required to produce a more intuitively satisfactory model [9].

A mathematical model applicable to the tumor cell line under the action of an inhibited, has been developed by Chou TC and Talalay P. The median effect equation describes the behavior of many biological systems. It is a generalized form of the enzyme kinetic relations of Michaelis-Menten and Hil [10].

Developing a complex mathematical model of cell fraction allows the 2D numerical simulation, in order to obtain a expression of status estimators. One could note that it is possible to develop mathematical models for analyzing the cellular fraction of *GB* based on a so-called indirect construction process of the mathematical pattern. Further it must be noted that a residue analysis allows validating the mathematical model of the dynamics of cellular fraction, based on the mathematical pattern that is built on a complex electronic structures encompassing a *RC* quadrupole and an operational amplifier *OA*.

## 2 Material and Method

Cell line *GB9B* was developed on the basis of tumor sections provided by Hospital *Bagdasar Arseni* in Bucharest, in patients with glioblastoma, according to standard procedures.

Standard culture medium, (Minimum Essential Medium - *MEM*), have been provided by the SIGMA – ALDRICH, (St. Louis, USA).

Fetal bovine serum (*FBS*), and antibiotics have been provided by the GIBCO, (South America).

The process of dynamic cell proliferation type, on the cell line *GB9B* was performed in the *Laboratory CRL*.

**Treatment of cells.** The cell line was grown in modified standard medium *MEM* (which is containing 10% fetal bovine serum (*FBS*), 1% antibiotics). The cells were grown in flasks (with size of 200ml), and were maintained in incubator at 37°C, 95%  $O_2$  and 5%  $CO_2$ . At each interval of 4 days was imposed changing the standard *MEM*.

The cell line was incubated for a period of 12 days. Cell viability was determined by daily counting of the cells number in pre-marked areas.

## 3 Results

Following the incubation process at which the cell line *GB9B* has been subjected, it has resulted a strong cell viability during the first 6 days from starting the incubation. The cell fraction of the *GB9B* line has a relatively small increase in the range of 7-8 days. Towards the end of the proliferation process the kinetic evolution is of landing. This effect continues until the end of the experiment, according to **Fig. 1**. We set the system variables as follows: *cellular fraction f* / *fraction compensated  $f_c$*  / *incubation time t*.

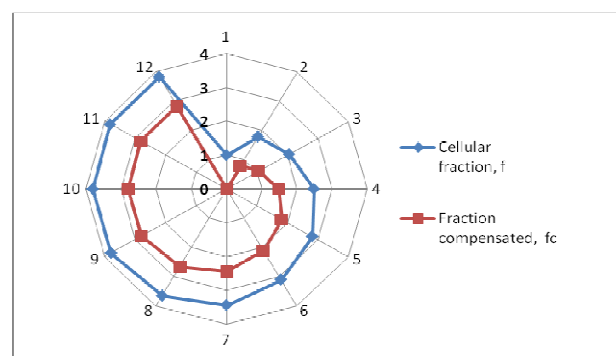

**Fig. 1.** Cellular fraction,  $f$  / Tumor cell line, *GB9B*; confidence interval,  $\pm 95\%$

Aspects of the specific geometrics of cell proliferation derived from *GB9B* are depicted in **Fig.2**.

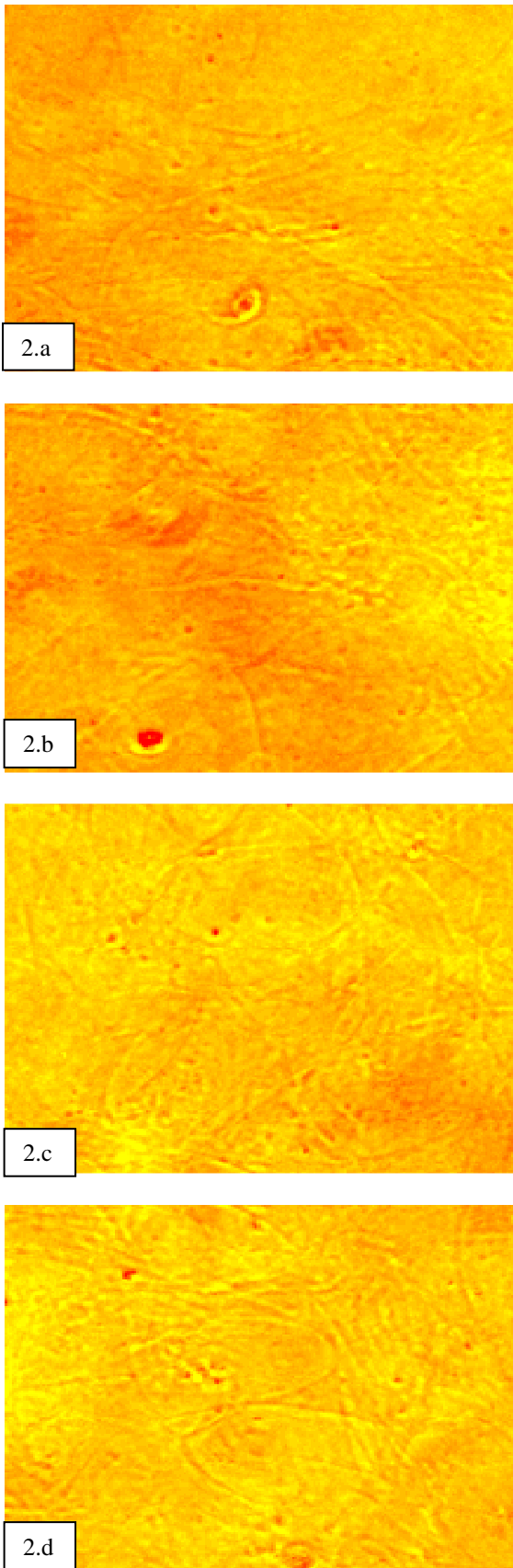

**Fig. 2.** Complex network of cell line GB9B, [17]

Construction of mathematical model for analyzing the cellular fraction of GB is done by analogy with electrical structure of electric passive quadrupole type. Based on complex electronic structure represented in **Fig. 3**, (composed mainly of the RC quadrupole, the signal repeater  $A_1$ , amplifier/signal inverting  $A_2, A_3$ ), we construct the mathematical model through operational calculus.

$$\text{We have relations: } u_1(t) = Ri + \frac{1}{C} \int idt \quad (1)$$

$$u_c(t) = \frac{1}{C} \int idt \quad (2),$$

$$u_2(t) = K_1 K_2 u_c(t) \quad (3).$$

It is possible to determine the system response to an input type function if the transfer function of the system is known:  $Y(p) = H(p) \cdot I(p)$  (4)

For a unit impulse function input  $I(p) = L[\delta(t)]$  (5)

$L[\delta(t)] = 1$  (6), output function is obtained directly

from the transfer function:  $Y(p) = H(p)$  (7)

To obtain the system response using inverse

transform:  $y(t) = L^{-1}[H(p) \cdot X(p)]$  (8)

Customize the previous relationship in our case,

system response is:  $K_1 K_2 \left( \frac{1}{p} \cdot \frac{1}{\tau p + 1} \right)$  (9) where:

$$\tau = RC \quad (10), \quad K_1 = \frac{R_5}{R_4} \quad (11), \quad K_2 = \frac{R_8}{R_7} \quad (12).$$

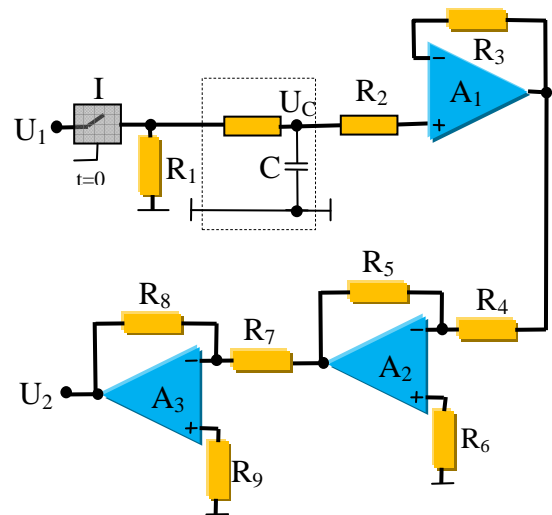

**Fig. 3.** Electronic structure: RC + OA, [17];  
 - the resistances  $R_1, R_2, R_6, R_9$  are undefined;  
 -  $A_1, A_2, A_3$ ; - precision OA with the input jFET; - I - CND; - the scheme does not apply to direct measurements.

$$K = K_1 \cdot K_2 = \frac{R_5}{R_4} \cdot \frac{R_8}{R_7} = \frac{R_5}{R_7} \quad (13), (R_4 = R_8),$$

$$\text{or: } K = K_1 \cdot K_2 = \frac{R_5}{R_4} \cdot \frac{R_8}{R_7} = \frac{R_8}{R_4} \quad (14), (R_5 = R_7).$$

Response system,  $Y(p)$ , (9), contains two poles, as stability elements for the electronic system. When applying at the  $RC$  quadrupole input, (at  $t=0$ ), an electric signal by magnitude  $U_1$ , at the output of the active structure will be obtained an electric signal that tends to the magnitude  $U_2$ , after a time interval that is a multiple of time constant  $\tau$ . Time constant of the  $RC$  quadrupole is  $\tau = RC$ . Taking into consideration the type of followed process, one could choose a time constant with a relatively large value, namely  $\tau = 3d$ . Calculated values based on the model:

$$\left[ L^{-1} \left[ \frac{R_5}{R_7} \left( \frac{1}{p} - \frac{\tau}{\tau \cdot p + 1} \right) \right] \right]_{t=0}^{t=4\tau} \quad (15)$$

$$\text{or } \left[ L^{-1} \left[ \frac{R_8}{R_4} \left( \frac{1}{p} - \frac{\tau}{\tau \cdot p + 1} \right) \right] \right]_{t=0}^{t=4\tau} \quad (16)$$

are predicted values.

The observed values are the values obtained on the basis of laboratory experiment by calculating fraction compensated  $f_c$ , obtained from the cellular fraction,  $f$ . Based on the observed values and predicted values can be residue analysis presented in **Fig. 4**. Residue analysis is based on the prediction error calculated as the difference between observed and predicted values.

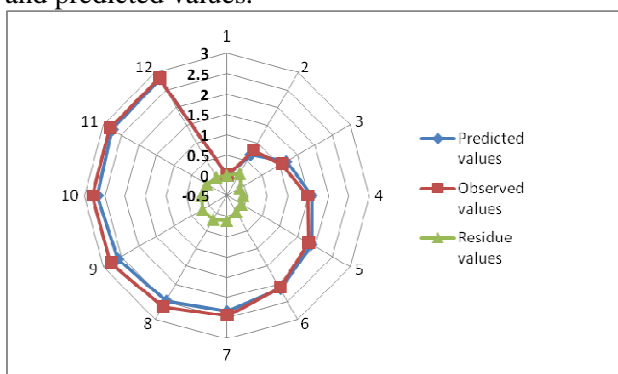

**Fig. 4.** Analysis of residues; confidence interval  $\pm 95\%$

### 4 Discussion and Conclusions

Cell line *GB9B* of type tumor cells *GB* was incubated in *Clinical research laboratory (CRL)* of UMF Craiova. The incubation process revealed a strong cell viability, accompanied by a large increase in the growth rate of the cell fraction dynamics.

In other research, conducted *in vivo* has been revealed the increase of tumor cell mass accompanied by microvascular proliferation of tumor tissues. The explanation is related to the need to ensure an optimal local energy resources [1]. This aspect of the optimum of local energy is defining in case of cultivation of cell lines derived from *GB*. It is required a constant refreshment of standard *MEM* culture medium (including fetal bovine serum - *FBS*, antibiotic), during the process of incubation.

The aspect of specific aggressivity of glioblastoma (*GB*) is supported by Wang R, et al. [11]. They pointed out a notable feature of *GB*, ie, an abnormal vascular network, which prints an enlarged tissue hyperplasia. Mechanisms of angiogenesis and tumor endothelial cell origin remain poorly defined.

Further on we would look for proving that a mathematical model described by a differential equation of order 2 with concentrated parameters could be accepted for a complex process of xenobiotic absorption [12]. Within the structure of a modulated absorption system, with a target type xenobiotic, one could identify specific elements of xenobiotic compounds dissipating type and accumulating type. As is already told, a mathematical model depicting a xenobiotic absorption process could be a differential equation of order 2 [14,16].

Continuous and sustained pursuit of subjects which have a xenobiotic induced retardation in speech is vital in the areas of permanent and intensive monitoring. Detection and quantification of retardation induced impermanent implementation on a subject affected by a xenobiotic can be implemented by using the elements of statistical analysis, more precise by watching crowd sounds appearances interrelated groups [13,15].

It is important in the study of tumor cell proliferation *in vitro* the construction of specific mathematical model of the process. We believe that the construction of the mathematical model in the form of the transfer function can be obtained by analogy with complex electronic structures, namely a *RC* quadrupole + *OA* (operational amplifier) [17].

It is possible to develop mathematical models of cellular fraction *GB* analysis based on a so-called indirect construction process of mathematical model. The mathematical model for analyzing the cellular fraction of *GB* was built indirectly by analogy with the mathematical model of a passive quadrupole of *RC* type. It is important that during the construction of such a model to have a mathematical model validation stage. Residue analysis allows to validate a mathematical model of

the dynamics of cellular fraction, based on the mathematical model built on complex electronic structure entailing a RC quadrupole + an operational amplifier OA [17, 18].

The transfer function of electronic structure RC quadrupole + operational amplifier OA determines forecast values for the proliferation process of tumor cells glioblastoma. Based on the analysis of residues one could accept that such a mathematical model:

$$\frac{R_5}{R_7} \left( \frac{1}{p} \cdot \frac{1}{\tau \cdot p + 1} \right) \quad (17)$$

or  $\frac{R_8}{R_4} \left( \frac{1}{p} \cdot \frac{1}{\tau \cdot p + 1} \right) \quad (18)$

or without customization:  $K \left( \frac{1}{p} \cdot \frac{1}{\tau \cdot p + 1} \right) \quad (19)$

is valid for the proliferation process of the cell line, GB9B, of GB tumor cell type.

The process of multiplexing we generated a series of specific curves proliferation process, as follows:

- **Fig. 5.** Numerical simulation on model type:  $|K / [p(\tau \cdot p + 1)]_0^{10}$  with  $\lim_{p \rightarrow 0} |1 + K / (\tau p + 1)| = 2$
- **Fig. 6.** Numerical simulation on model type:  $|K / [p(\tau \cdot p + 1)]_0^{10}$  with  $\lim_{p \rightarrow 0} |1 + K / (\tau p + 1)| = 3$
- **Fig. 7.** Numerical simulation on model type:  $|K / [p(\tau \cdot p + 1)]_0^{10}$  with  $\lim_{p \rightarrow 0} |1 + K / (\tau p + 1)| = 4$

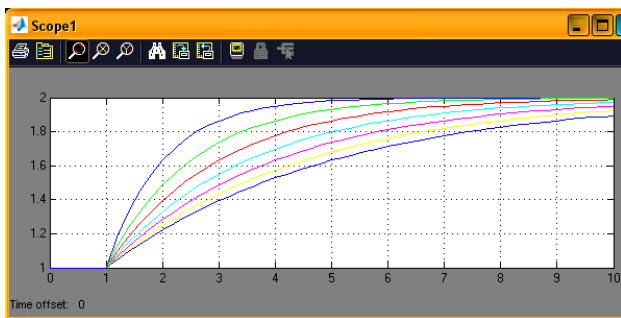

**Fig. 5** Numerical simulation:  $1 + L^{-1} |K / [p(\tau p + 1)]_0^{10}$   
 $K=1; \tau=1; 1.5; 2; 2.5; 3; 3.5; 4$

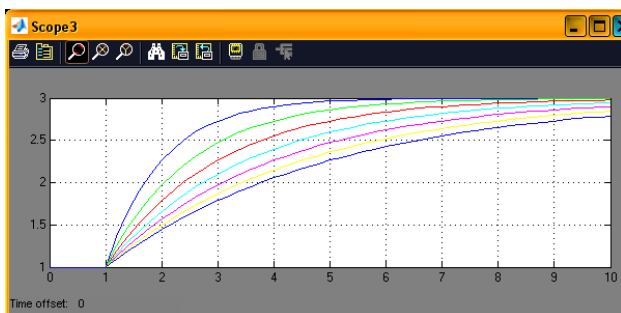

**Fig. 6** Numerical simulation:  $1 + L^{-1} |K / [p(\tau p + 1)]_0^{10}$   
 $K=2; \tau=1; 1.5; 2; 2.5; 3; 3.5; 4$

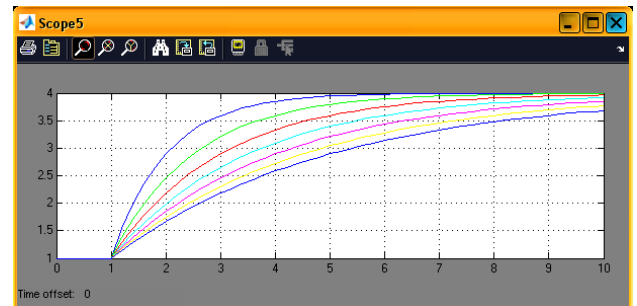

**Fig. 7** Numerical simulation:  $1 + L^{-1} |K / [p(\tau p + 1)]_0^{10}$   
 $K=3; \tau=1; 1.5; 2; 2.5; 3; 3.5; 4$

In the process of tumor cell proliferation control in the laboratory, it is necessary medium change from time to time. Numerical simulation on the computer, allows to obtain results doors for laboratory research. Mathematical models by numerical simulation, allowing obtaining valid results when the input values of different sizes in the process of cell proliferation. The multiplexing process we generated a new series of specific curves proliferation process. In case of media with the same time constant but different proliferative factors may be numerically simulate the process of cell proliferation, which depends on the exchange rate of the working medium, as follows:

- **Fig. 8.** Numerical sim. on model:  $|K / [p(p + 1)]_0^{10}$  ;  
 $\lim_{p \rightarrow 0} \left[ 1 + \sum K_i / (p + 1) \right] = 5$  where  $K_i = 1$ ;
- **Fig. 9.** Numerical sim. on model:  $|K / [p(p + 1)]_0^{10}$  ;  
 $\lim_{p \rightarrow 0} \left[ 1 + \sum K_i / (p + 1) \right] = 5$  where  $K_1=1; K_2=3$ ;

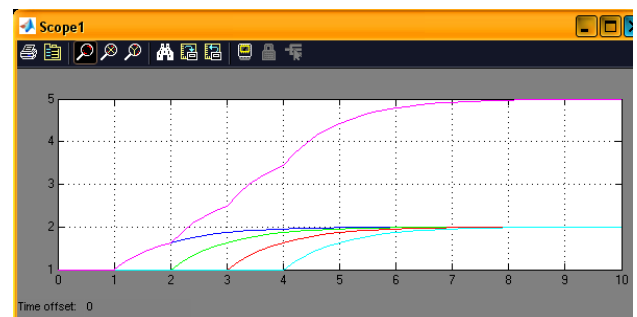

**Fig. 8.** Numerical sim.:  $1 + L^{-1} |K_i / [p(p + 1)]_i^{10}$   
 $\sum \left[ 1 + L^{-1} |K_i / [p(p + 1)]_i^{10} \right], (i=1; 2; 3; 4), (K_i=1)$



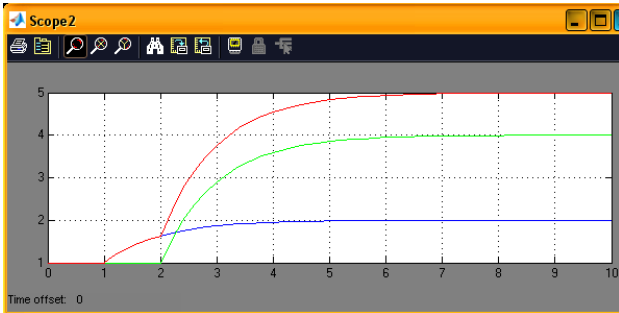

**Fig.9.** Numerical sim. :  $1 + L^{-1}|K_i/[p(p+1)]_i^{10}$   
 $\sum [1 + L^{-1}|K_i/[p(p+1)]_i^{10}]$  (i=1;2), (K<sub>1</sub>=1;K<sub>2</sub>=3)

In case of media with the same proliferative factors but different time constant may be numerically simulate the process of cell proliferation, as follows:

- **Fig. 10.** Numerical simulation on model type:

$$|K/[p(\varphi+1)]_0^{10}; \lim_{p \rightarrow 0} \left[ 1 + \sum K_i / (\tau_i p + 1) \right] = 5$$

where K<sub>1,2</sub>= 1; K<sub>3</sub>= 2; τ<sub>1,2</sub>= 1; τ<sub>3</sub>= 2;

- **Fig. 11.** Numerical simulation on model type:

$$|K/[p(\varphi+1)]_0^{10}; \lim_{p \rightarrow 0} \left[ 1 + \sum K_i / (\tau_i p + 1) \right] = 5$$

where K<sub>1</sub>= 1; K<sub>2</sub>= 3; τ<sub>1</sub>= 1; τ<sub>2</sub>= 3.



**Fig. 10.** Numerical sim. :  $1 + L^{-1}|K_i/[p(\tau_i p + 1)]_i^{10}$   
 $\sum [1 + L^{-1}|K_i/[p(\tau_i p + 1)]_i^{10}]$  K<sub>1,2</sub>=1K<sub>3</sub>=2,τ<sub>1,2</sub>=1τ<sub>3</sub>=2

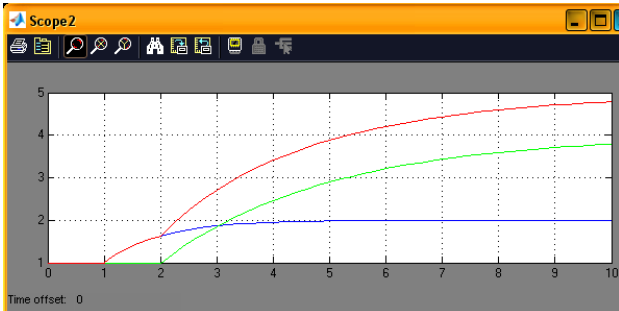

**Fig.11.** Numerical sim. :  $1 + L^{-1}|K_i/[p(\tau_i p + 1)]_i^{10}$   
 $\sum [1 + L^{-1}|K_i/[p(\tau_i p + 1)]_i^{10}]$ ; K<sub>1</sub>=1,K<sub>2</sub>=3,τ<sub>1</sub>=1,τ<sub>2</sub>=3

It is believed that the process of proliferation of tumor cells GB is defined by the points: [τ,(1-e<sup>-1</sup>)], [2τ,(1-e<sup>-2</sup>)], [3τ,(1-e<sup>-3</sup>)], [4τ,(1-e<sup>-4</sup>)].

Calculation of standard residues explains our choice to accept indirect construction of the mathematical model specific to this biochemical process by cell dynamic type on tumor cells GB.

**References:**

- [1] Chen,J., Li,Y., Yu,T.S., McKay, R.M., Burns,D.K., Kernie,S.G., Parada,L.F.: A restricted cell population propagates glioblastoma growth after chemotherapy. *Nature*, 488: 522-526, 2012.
- [2] Fukushima T., Takeshima H., Kataoka H.: Anti-glioma therapy with temozolomide and status of the DNA-repair gene MGMT. *Anticancer Res.*, Nov;29(11):4845-54. 2009.
- [3] SefTOR, R., Hess, A., SefTOR, E., et al.: Tumor Cell Vasculogenic Mimicry: From Controversy to Therapeutic Promise. *The American Journal of Pathology*, 181-4: 1115-1125, 2012.
- [4] Maniotis, A.J., Folberg, R., Hess, A., SefTOR, E.A., et al.: Vascular channel formation by human melanoma cells in vivo and in vitro: vasculogenic mimicry, *The American Journal of Pathology*, 155:739-752, 1999.
- [5] Cheng, L., Huang, Z., Zhou, W., et al.: Glioblastoma stem cells generate vascular pericytes to support vessel function and tumor growth, *Cell*, 153:139-152, 2013.
- [6] Soda, Y., Marumoto, T., Friedmann-Morvinski, D., et al.: Transdifferentiation of glioblastoma cells into vascular endothelial cells, *Proc Natl Acad Sci USA*, 108:4274-4280, 2011.
- [7] Ricci-Vitiani, L., Pallini, R., Biffoni, M., et al.: Tumour vascularization via endothelial differentiation of glioblastoma stem-like cells. *Nature*, 468:824-828, 2010.
- [8] Skipper, 11., Schabel, F.Jr.: Quantitative and cytotoxic studies in experimental tumor systems. In: *J. F. Holland and E. Frei III (eds.). Cancer Medicine*, Ed. 2, pp. 636-648. Philadelphia: Lea and Febiger, 1982.
- [9] Norton, L. A.: Gompertzian model of human breast cancer growth. *Cancer Res.*, 48, 7067-7071, 1998.
- [10] Chou, T.C., Talalay, P.: Quantitative analysis of dose-effect relationships: the combined effects of multiple drugs or enzyme inhibitors. *Adv Enzyme Regul* 22: 27-55, 1984.

- [11] Wang, R., Chadalavada, K., Wilshire, J., et al.: Glioblastoma stem-like cells give rise to tumour endothelium, *Nature*, 468:829-833, 2010.
- [12] Bulucea, C.A., Rosen, M.A., Mastorakis, N.E., Brindusa, C.C., Bulucea, C.A.: Approaching Resonant Absorption of Environmental Xenobiotics Harmonic Oscillation by Linear Structures. *Sustainability*, doi:10.3390/su40x000x, 2012.
- [13] Brîndușa, C.A., Gofiță, E.: Detection and quantification of retardation induced by certain xenobiotics, *WSEAS RECENT RESEARCHES in MEDICINE, BIOLOGY and BIOSCIENCE*, Chania, Crete Island, Greece, pp 70-75, 2013.
- [14] Bulucea, C.A., Brîndușa, C.C., Mastorakis, N.E., Bulucea, C.A., Jeles, C.A.: Harmonic structures for environmental xenobiotic absorption kinetics, *IEEEAM/NAUN International Conferences Prague on WORLD MEDICAL*, Czech Republic, pp. 192-196, 2011.
- [15] Jeles, C.A., Brîndușa, C. C., Păsculescu, D.: Manifestations of retardation induced by certain xenobiotics. *5th International Multidisciplinary Scientific Symposium, SIMPRO 2012, University of Petroșani, România*, pp. 37-42, 2012.
- [16] Bulucea, C.A., Mastorakis, N.E., Rosen, M.A., Brîndușa, C.C., Bulucea, C.A., Jeles A.: Enhancing Understanding of the Environmental Xenobiotics in Coal-Fired Flue Gas, *Recent Researches in Environment and Biomedicine, Proceedings of the 6th International Conferences on Energy and Development Environment - Biomedicine (EDEB'12)*, Vouliagmeni, Athens, Greece, pp.58-67, 2012.
- [17] Brîndușa, C.C., Dondon, P., Bulucea, C.A.: Indirect identification of transfer function specific to cell line dynamics. *EMET 2014 - The 2014 International Conference on Education and Modern Educational Technologies*, Santorini Island, Greece, pp.17-21, 2014.
- [18] Brîndușa, C.C., Mastorakis, N.E., Bulucea, C.A.: Determination of the kinetic model for cell line on the duration of action of an inhibitor of tyrosine kinases receptors. *MCSI'14 - The 2014 International Conference on Mathematics and Computers in Sciences and Industry*, Varna, Bulgaria, 2014, in press.