

Excitation of *Paramecium* with Membrane Potential Generation for Swimming Direction by Cilia

Yumi Takizawa[†], Atsushi Fukasawa[†], and Hiro-aki Takeuchi^{††}

[†]Institute of Statistical Mathematics
Research Organization of Information and Systems
10-3 Midori-cho, Tachikawa, Tokyo, JAPAN
takizawa@ism.ac.jp

^{††}Department of Biological Science
Graduate School of Science
Shizuoka University, Shizuoka, JAPAN
sbhtake@ipc.shizuoka.ac.jp

Abstract: - Modelling and analysis are presented for excitation of *paramecium*. Excitations are characterized by difference in time durations (pulse and plateau) and polarities (positive and negative) of potentials. The former is used for backward swimming against stimulus at the front of the body, the latter is used for forward fast swimming against stimulus at rear of the body. This paper gives electro-physical modellings for two kinds of excitation modes. Injection of Ca^{2+} ions and ejection of K^{+} ions are assigned for two kinds of excitation modes. Modelling of *paramecium* with Ca^{2+} and K^{+} channels are found common to modelling of neuron with Na^{+} and Cl^{-} channels.

Key-Words: -Excitation of *paramecium*, *paramecium* of unicellular organism, positive and negative potential generation, swimming directions by cilia.

1 Introduction

Ectoplasm membrane potential of *paramecium* was first measured by T. Kamada, 1934[1]. The relation between polarity (sign) of membrane potential and swimming direction with cilia was then studied by Y. Naitoh and R. Eckert, 1969[2,3]. They showed that positive potential causes backward swimming, and negative potential causes quick forward swimming.

The response above was given for external stimulation. Recently, spontaneous generation of potential in *paramecium* was observed at the front and the rear parts of the body (cell).

It indicates that intracellular potential is not uniform at the part of the body (i.e. of the cell)[4]. Electro-physical modelling is given for two modes of excitation modes. Injection of Ca^{2+} ions and ejection of K^{+} ions are assigned for two modes of excitation modes. Now comparative studies are needed for both of neuron and *paramecium* or other unicellular organism.

Modelling of *paramecium* with Ca^{2+} and K^{+} channels corresponds to the modelling of neuron with Na^{+} and Cl^{-} channels.

It is found that unified modelling of excitatory cells is realistic for different kinds of animals. And it is also said that difference in kinds of ion channels depends on the difference of the environment. Namely limnetic animal of *paramecium* utilizes Ca^{2+} and K^{+} ions in water, marine animal of *noctiluca* and neurons utilize Na^{+} and Cl^{-} in water.

In this paper, electro-physical modelling of positive pulse generation for Ca^{2+} injection is given referred to the knowledge of neurons[5-9]. Then electro-physical modelling of negative pulse generation for K^{+} ejection is given referred to the study by the authors[9,10].

It is also presented that if second messenger ion channels are utilized in place of ionic channels at input port, plateau (waveform) is generated to keep continuous state with long time delay.

Lastly, it is presented that characteristic potentials defines the multiple (typically four) modes of excitations to provide variety of motions by cilia.

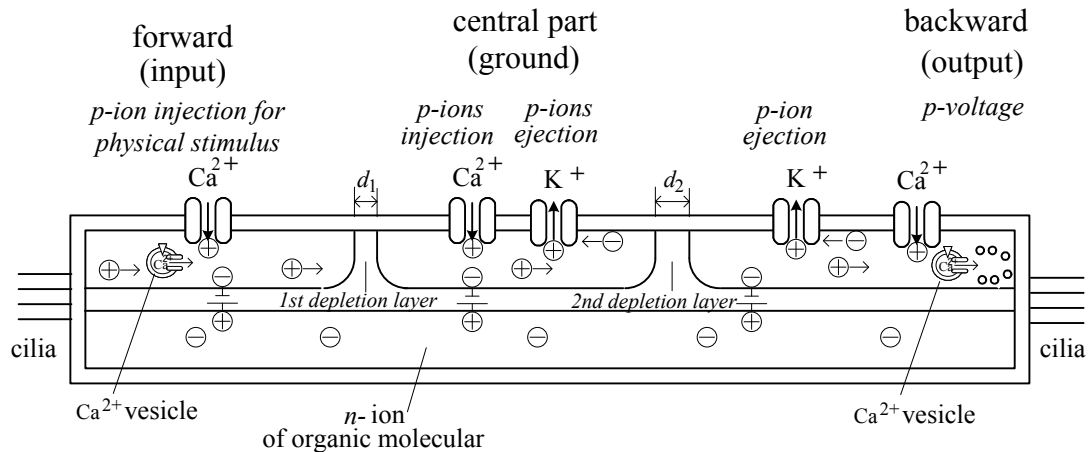

Fig.1 Electro-physical modelling of *paramecium* for positive excitation (de-polarization). *Paramecium* swims backward by cilia with positive potential excitation. *Paramecium* lives in limnetic environment being less NaCl.

2 Electro-Physical Modelling of Positive Potential Generation

2.1 Configuration of electro-physical modelling

The model and analysis in this study are made under time- and space-dependent motions of Ca^{2+} and K^+ in cytoplasm.

Electro-physical modelling is first given for generation of positive potential pulse and plateau. Equational analysis is presented by open-loop gain and feedback ratio for positive pulse generation. Mechano-sensitive, ionotropic and voltage sensitive Ca^{2+} channels are taken for the model. This model proves existence of feedback in the equivalent circuit.[5-9]

Electro-physical modelling is then given for generation of negative potential pulse and plateau. This model is common with the above model except configuration of ion channels. [9,10]

2.2 Operation for positive potential output

Electro-physical modelling of positive potential generation is given in Fig. 1.

Mechanosensitive Ca^{2+} channels are at the forward part of body. Voltage dependent Ca^{2+} channels are assumed at the central and at the backward parts of body.

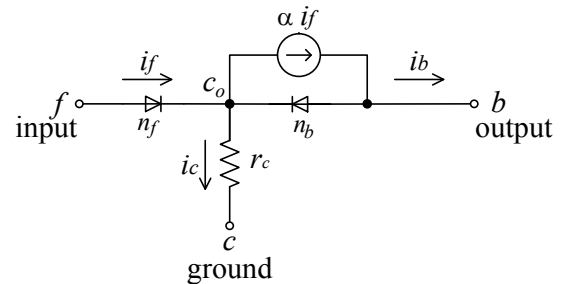

Fig. 2 Electrical modelling of activity of *paramecium* for positive potential output.

For mechanical stimulation at the forward part (input), reception potential appears by influx of Ca^{2+} through Ca^{2+} channels, or release from Ca^{2+} vesicles in the cell.

When the potential variation signal reach at the central part, influx of Ca^{2+} through voltage-dependent Ca^{2+} channels is induced and the potential difference between two zones (input and control) is reduced.

By reduction of the potential difference, Ca^{2+} charges pass over the first boundary. And Ca^{2+} charges diffuse toward the second boundary.

The potential difference is kept high at the second boundary by lack of ion channels for potential compensation (reduction) at the backward. However Ca^{2+} pass over the potential gap by the thermal energy. Positive Ca^{2+} charges are pulled with negative potential bias to provide amplified potential output.

Positive potential output causes excitation to drive the cilia for backward swimming.

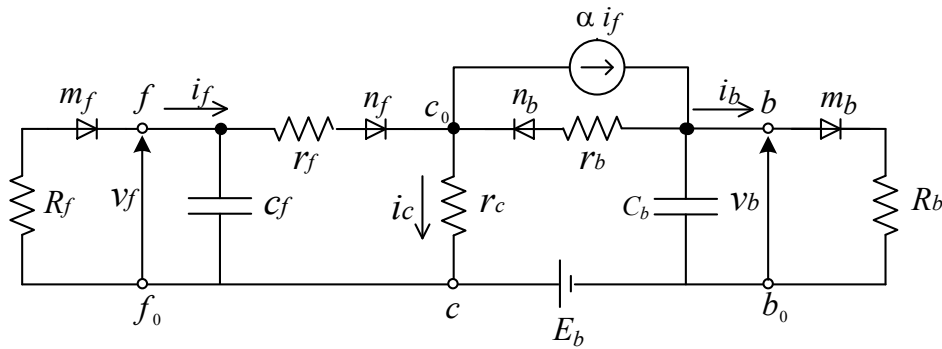

Fig. 3 Electrical modelling for positive potential output. Input R_f represents equivalent expression of mechanical stimulation.

2.3 Equivalent circuit of activity and active cell

2.3.1 Electrical modelling of activity

Electrical modelling of activity for positive potential output is shown in Fig.2.

Input and output diodes n_d, n_a correspond to the first and the second depletion layers, which are shown as forward and reverse diodes respectively.

α is current multiplication factor. A part of input i_f is lost to be i_c during diffusion at the central part by reconnection of p - and n - ions.

$\alpha \cdot i_d$ is equivalent current source flowing output circuit. r_c is the diffusion resistance of p -charges through the central part, which provides feedback action.

2.3.2 Characteristics as an amplifier

Electrical modelling of an active cell is shown in Fig. 3. The points of f_0, b_0 are outside of membrane. c_0 is a virtual point taken in the central part.

r_f and r_b are resistances of forward and reverse diodes n_f and n_b . r_c corresponds to diffusion loss at the central part and brings feedback from output and input circuit.

Resistances m_f and m_b are equivalent expressions of input stimulus and output potential for motion of cilia or chemical secretion.

The capacitances C_f and C_b are caused by the first and second depletion layers respectively. Input and output diodes m_f and m_b are shown as forward diodes for influx of p -ions. These diodes work for efflux of n -ions.

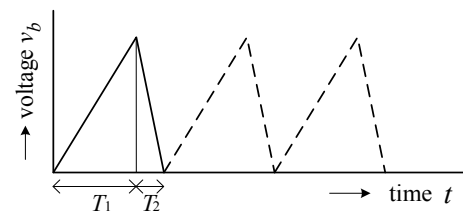

Fig.4 Positive potential voltage output. Dotted lines corresponds to multiple pulse generation.

Electrical energy is enhanced by active operation in cytoplasm in the cell of *paramecium*. Energy enhancement gain is given by voltage amplification gain. It is pointed that current amplification gain is regarded as 1 [5].

Voltage amplification gain G is given as;

$$G = \frac{v_b}{v_f} = \frac{\frac{\alpha R_b}{r_f + r_c}}{1 - \frac{\alpha R_b}{r_f + r_c} \cdot \frac{r_c}{R_b}} = \frac{K}{1 - K\beta} \quad (1)$$

$$K = \alpha \frac{R_b}{r_f + r_c} \quad (2)$$

$$\beta = \frac{r_c}{R_f} \quad (3)$$

where, v_f and v_b are input (reception potential) and output (action potential) voltages, G, K, β are closed loop gain, open loop gain, and inner feedback ratio respectively. Oscillation condition is given by $K\beta \geq 1$.

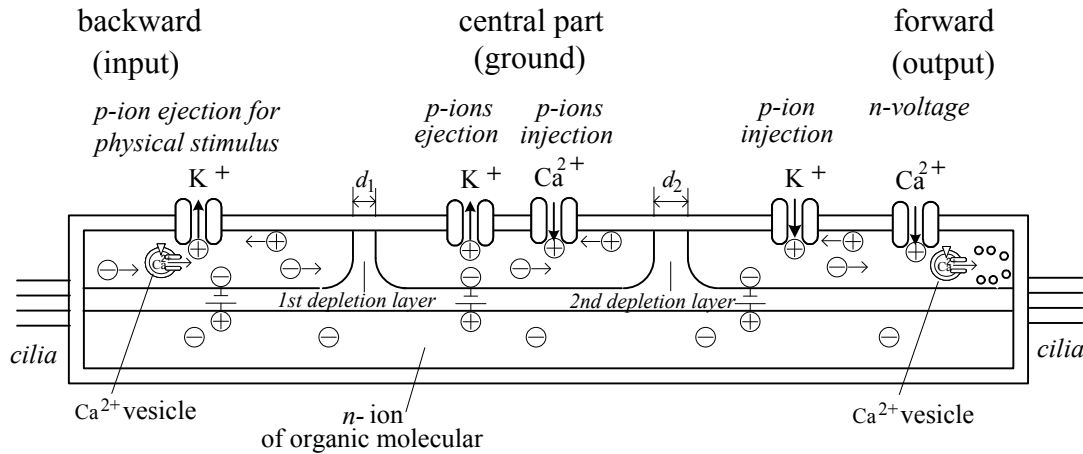

Fig. 5 Electro-physical modelling of *paramecium* for negative excitation (hyper-polarization). *Paramecium* swims forward rapidly by cilia with negative potential excitation.

In case that $\alpha < 1$, $K\beta \ll 1$. Therefore the cell operates as a voltage amplifier with threshold for input signal with positive inner feedback.

2.3.3 Characteristics as a positive potential waveform generator

The cell operates as an oscillator to generate the output of potential waveforms when the product of open loop gain K and feedback ratio β exceeds 1.

Self-injection oscillation is done by $K\beta \geq 1$.

$$T_1 = C_f \frac{r_c R_b}{r_c + R_b} \quad (4)$$

$$T_2 = C_b R_b \quad (5),$$

where, $R_f + r_f \gg r_c$, $r_b = \infty$ are assumed for simplified analysis.

The period of oscillation T is given as the total time length as following;

$$T = T_1 + T_2 = C_f \frac{r_c R_b}{r_c + R_b} + C_b R_b \quad (6).$$

The mode of oscillation is astable, because the stable point is less except zero (0) potential.

The cell operates as an astable mode tuned to external injection. Whenever, the phase and the period of original free running oscillator is

fluctuating, the oscillator becomes stable by locking to the external signal as shown in Fig. 4.

3 Electro-Physical Modelling of Negative Potential Generation

Electro-physical modelling and the equivalent circuits of negative potential generation are given in Fig. 5, 6, and 7.

In Fig. 5, K^+ is used for negative potential generation. Against input mechanical stimulation at the backward part, negative reception potential is induced at input port by efflux of K^+ through mechanosensitive K^+ channels (pulse), or chemical process for production of cyclic AMP as the second messenger mediated by some enzyme from ATP.

When the potential drops down under the resting potential, K^+ efflux is induced at the central part to reduce the potential difference between two zones.

Electro-physically, loss (efflux) of positive charges (K^+) is equivalent to gain (influx) of negative charges. Negative potential generation takes place at the forward part of body. The animal moves forward with twice higher speed than usual swimming, it means the other type of excitation.

It is pointed that negative potential (hyperpolarization) excitation does not mean so called inhibition (suppression) of positive potential excitation.

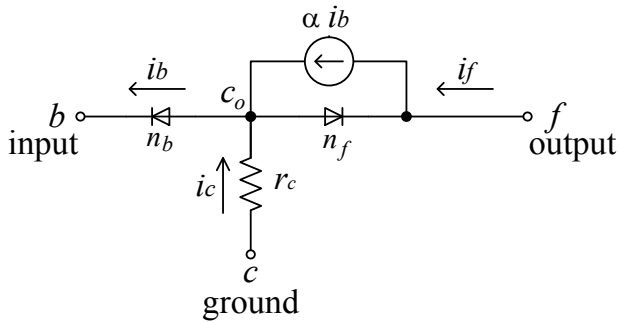

Fig. 6 Equivalent circuit of activity.

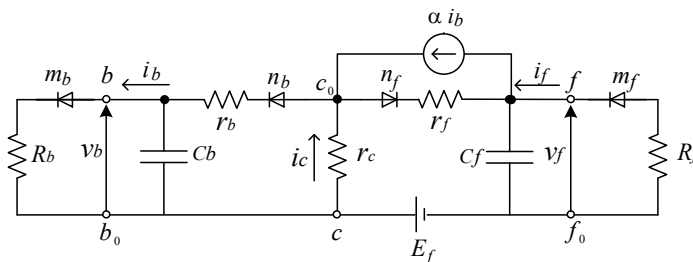
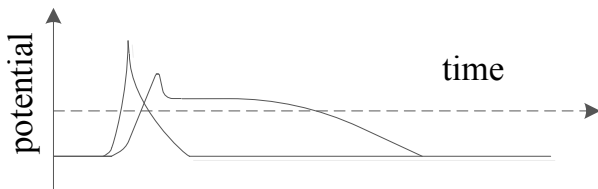
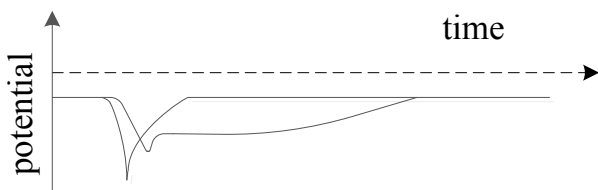

Fig. 7 Equivalent circuit of excitatory cell.



(a) Positive potential waveform



(b) Negative potential waveform

Fig. 8 Output bipolar waveform with short and long time durations.

4 Bipolar Potentials in *Paramecium*

4.1 Modelling of output potential waveforms

Expected output potential waveforms for excitatory cell are given in Fig. 8 based on the above schemes. Output waveforms in the figure are drawn by superimposing.

4.2 Motion of cilia by bipolar potentials in *paramecium*

It is known that *paramecium* swims by cilia driven by bipolar potentials. It moves backward and forward responding to external stimulus applied at forward and backward parts of the cell respectively. These movements are driven by positive potential (depolarization) and negative potential (hyperpolarization) generated in the cell.

It is also found in experiments that output waveforms are featurized by short (pulse) and long (plateau) time durations of continuation, but the role of modulation of waveforms were not known enough, but it is expected that a plateau continues motion, and a pulse enhances action of motions in advance of a plateau. It is also fed that the pulse (spike) happens in short time, and the plateau keeps potentials long time enough for the motion.

4.3 Bipolar Potentials in *Paramecium* with Ca^{2+} and K^+ ion channels

4.3.1 Positive pulse and plateau

- Pulse (spike)

Mechanosensitive Ca^+ channels are first considered at forward (input) in Fig. 1.

Ca^+ channels open quickly after reception of mechanical stimulus. By late efflux of K^+ , the potential at the central part (control) return rapidly from active (positive) to resting (negative) potentials.

- Plateau

Ca^+ channels are secondly considered at forward (input) in Fig. 1.

Ca^+ channels open lately after reception of the first messenger by chemical process for the second messenger in cytoplasm.

Voltage dependent Ca^+ channels at the central part and at the backward produce plateau to keep enough time for steady operation.

4.3.2 Negative pulse and plateau

- Pulse (spike)

Mechanosensitive K^+ channels for efflux are also considered at forward part (input) in Fig. 5.

K^+ channels open quickly after reception of mechanical stimulus. By late influx of Ca^+ , the potential at the central part (control) returns quickly from active (deeply negative) to resting (negative) potentials. [2,11,12]

- Plateau

Mechanosensitive K^+ channels are also considered at the backward (input) in Fig. 5.

Mechanosensitive K^+ channels open lately after reception of the first messenger by chemical process for the second messenger in cytoplasm.

Voltage dependent K^+ channels at the central part and at forward part produce plateau output potential to keep enough time for steady operation.

5 Commonality of Excitation in *Paramecium* and Neuron

In *paramecium*, influx of Ca^{2+} provides positive potential and efflux of K^+ provides negative potential, and bipolar potentials are used for control of motion of cilia.

Positive (depolarization) and negative (hyperpolarization) potential plateau, and positive (depolarization) potential pulse are utilized in *paramecium*, and negative (hyperpolarization) potential pulse is generated under conditions of external and internal kind and density of ions [4].

In neurons, influx of Na^{2+} provides positive potential, and influx of Cl^- provides negative potential. Bipolar potentials are used mainly in for short potential pulses.

Recent studies inform that cyclic AMP (adenosine monophosphate) plays important roles in neural cells. This chemical material work to open or to close the gates of ion channels as the second messenger. It takes long delay time for chemical process of metabolism. Ca^{2+} works like c-AMP.

Bipolar potentials are used mainly for control of sensing and motor neurons, and for secretion of hormone and neurotransmitter.

This paper proves that similarity exists in principles of generation of plateaus.

6 Conclusion

Electro-physical modelling and equivalent circuit of excitation (activity) in *paramecium* were first presented in this paper.

It is known that *paramecium* swims backward for the stimulation given at front part of the body with positive potential generation. It is also known that it swims forward with about twice speed of usual swimming.

Conventionally negative potential generation was interpreted as inhibitory response with rapid forward swimming. This interpretation was wrong and brought by assumption of inhibition in neuron.

This paper made clear electro-physically that negative potential generation was not inhibition but the other mode of excitation.

Different point in modelling of *paramecium* and neuron depends only on the kinds of ions and ion channels.

The authors are now trying to give evidence of the proposed model and analysis by biophysical experiments on comparative study of neuron and *paramecium* and other unicellular organisms.

References:

- [1] Kamada T., Some observations on potential difference across the ectoplasm membrane of *Paramecium*, *Journal of Experimental Biology*, vol. 11, pp.94-102, 1934.
- [2] Naitoh Y., Eckert R., Ionic mechanisms controlling behavioral responses of *paramecium* to mechanical stimulation, *Science*, 164, pp. 963-965, 1969.
- [3] Naito Y., Electrical conduction and behaviour in 'simple' invertebrates (G. A. B. Shelton, ed.), Clarendon Press, Oxford, 1982.
- [4] Nakaoka Y., Imai T., Hara M., Hashimoto N., Spontaneous fluctuation of the resting membrane potential in *Paramecium*: amplification caused by intracellular Ca^{2+} , *Journal of Exp. Bio.*, vol. 212, pp. 270-276, 2009.
- [5] Fukasawa A., Takizawa Y., Activity of a Neuron and Formulation of a Neural Group for Synchronization and Signal Processing, *Proc. of the International Conference on Neurology*, pp.242-247, Kos, Greece, July 2012, "The Best Paper Prize of NEUROLOGY'12" awarded by WSEAS/NAUN.
- [6] Fukasawa A., Takizawa Y., Activity of a Neuron and Formulation of a Neural Group for Synchronized Systems, *International Journal*

of Biology and Biomedical Engineering, Issue 2, vol. 6, pp. 149-156, 2012.

- [7] Takizawa Y., Fukasawa A., Formulation of a Neural System and Modelling of Topographical Mapping in Brain, *Proc. of International Conference on Circuits, Systems, Control, Signals (CSCS'12)*, pp. 59-64, Barcelona, Spain Oct. 17-19, 2012.
- [8] Fukasawa A., Takizawa Y., Activity of a Neuron and Formulation of a Neural Group based on Mutual Injection in keeping with system synchronization, *Proc. of International conference on Circuit, Systems, Control, Signals (CSCS'12)*, pp. 53-58, Barcelona, Spain, Oct. 17, 2012.
- [9] Fukasawa A., Takizawa, Activity of a Neuron for Generation of Pulse and Plateau with Positive and Negative Potentials, *Proc. of Health Science and Biomedical Systems (HSBS'15)*, pp.65-71, Aug. 17, 2015.
- [10] Takizawa Y., Fukasawa A., Takeuchi H. A., Positive and Negative Action Potentials in *Paramecium* relating to Neurons, *Proc. of Health Science and Biomedical Systems (HSBS'15)*, pp.54-60, Aug. 17, 2015.
- [11] Hinrichsen R. D., Schultz J. E., *Paramecium*: a model system for the study of excitable cells, *Trends in Neurosciences*, vol.11, no.1, pp.27-32, 1988.
- [12] Hinrichsen R. D., Fraga D., Russell C., The regulation of calcium in *Paramecium*, In: *Advances in Second Messenger and Phosphoprotein Research* (ed Means A.), vol.30, pp.311-338, 1995.
- [13] Sakurai H., Takeuchi H., Mechanism for disturbance of nervous system and behavior by endocrine disrupting chemicals – neuroethological and pharmacological analysis by using *Paramecium caudatum* –, *Proc. of the 14th annual meeting of JSEDR*, p.364, 2003.
- [14] Castsigeras E., Self-synchronization of networks with a strong kernel of integrate and fire excitatory neurons, *WSEAS Transactions on Mathematics*, Issue 7, Vol. 12, pp.786–797, July 2013.
- [15] Takizawa Y., Fukasawa A., Takeuchi H.-A., Electrical Measurement Method of Liquid Zones and Boundaries in Active Neuron, *Proc. of International Conference on Health Science and Biomedical Systems (HSBS '14)*, pp.11-15, Nov. 22, 2014.
- [16] Takizawa. Y., Fukasawa A., Takeuchi H.-A., Measurement of Liquid Zones and Boundaries in Active Neuron with Pairs of Micro Glass-Electrodes, *International Journal of Biology and Biomedical Engineering*, vol. 9, pp.42-47, 2015.

Appendix

Paramecium is a kind of unicellular organism. A schematic figure is shown in Fig. A1 for *paramecium ciliophora*.

It swims backward against mechanical stimulus at the front part of body (anterior). This motion is driven by positive action potential generated in a cell.

On the contrary, it swims forward quickly against stimulus at rear part (posterior). This motion is driven by negative action potential.

It is confirmed that mechano-sensitive Ca^{2+} and K^+ channels are distributed on surface of the body, and voltage-sensitive Ca^{2+} and K^+ channels are distributed at somewhere on surface of the body.

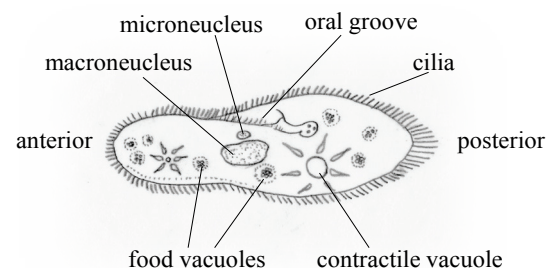

Fig. A1 *Paramecium ciliophora*.