

## **Self-Algorithm Traffic Light Controllers for Heavily Congested Urban Route**

S. K. SUBRAMANIAM<sup>1</sup>, M. ESRO<sup>2</sup> and F. L. AW<sup>3</sup>

<sup>1</sup>Lecturer, Department of Industrial Electronics Engineering  
Faculty of Electronics and Computer Engineering

<sup>2</sup>Senior lecturer, Department of Industrial Electronics Engineering  
Faculty of Electronics and Computer Engineering

<sup>3</sup>Graduate student, Department of Telecommunication Engineering  
Faculty of Electronics and Computer Engineering

Universiti Teknikal Malaysia Melaka  
MALAYSIA

[siva@utem.edu.my](mailto:siva@utem.edu.my), [mazran@utem.edu.my](mailto:mazran@utem.edu.my), [lyaw87@hotmail.com](mailto:lyaw87@hotmail.com)

*Abstract:* - Traffic lights are commonly known as the stop light or stop-and-go lights used as a source of signaling device in junctions around the world. It is common to position traffic lights on a certain road intersections, pedestrian crossings and other locations to control competing flows of traffic in order to enhance the smoothness of traffic flow. Traffic lights have been installed in most cities around the world regardless of different standards set by the local authorities. Traffic light controllers is programmed to assign timely directions for road users by demand in the form of colors which is Red, Amber and Green. Even though traffic lights are known as the best device in controlling traffic flow for road users, yet accidents reported at the traffic junction is very common. There are 2 methods in controlling the traffic light system placed on a certain junction. The most common one is the sequencing method, whereby the traffic light system is designed to operate according to the preprogrammed sequence without any consideration of real time behavior. The second method is the demand based controller which response to the preprogrammed timer based on real time sensor detection on a certain road junction. With both method widely used around the world, surety on traffic flow smoothness is not established. When authorities talk about efficiency and accuracy on real time traffic flow control, there are always room for further enhancement especially on the controlling and sensing method. In the afford to provide a solution for such miseries, a novel implementation of sensing method which will be incorporated with self conditioning program will be a practical solution. The new sensing method is capable of counting the total number of vehicles entering a certain junction and exiting from a certain junction on real time basis. Based on this detection, the programmable logic controller will trigger the traffic light indicators according to real demand. The new method should also be easy for further enchantment of traffic light system in ensuring smoothness of traffic flow especially during peak hours.

*Key-Words:* -Traffic Light System, self-algorithm traffic light, multiple junction traffic light, metal detector, programmable logic controller.

### **1 The traffic scenario**

Nowadays, vehicles have rapidly increasing throughout the world, particularly in large urban areas [1]. Therefore the need arises for a simulating and optimizing system for the traffic controllers to better accommodate this increasing demand by road users around the world [1].

Traffic lights are commonly used device to regulate roadway intersection traffic with a view to both safety and smoothness of vehicle flow [2] for generations where it is still considered the best

practices. Since the traffic light was invented ages ago, there were significant revolution have been down in various aspects of it. The most common revelation which we can visualize is the displays of traffic light itself. The other revolution which is being enhanced and improved is the traffic light controllers. The need to improve the efficiency of the controller plays an important role as the increasing number of vehicles in the road is tremendously in a large amount.

There are a lot of benefits to improve the traffic flow. Many road users reclaimed that by improve

the traffic flow can enhance their quality of life and less traffic congestion and therefore reduce the possibility of accidents and saving the life. Apart from that, the drivers can make most of it thru saving in terms of fuel consumption. As the traffic build up at a certain intersection, vehicles have to crawl in and out of the junction most of the time.

Furthermore, time spent by drivers traveling to and from work is not time spent doing work [3]. In fact, most people are essentially constrained to perform only the task of driving as they commute [3]. Goods must transport and service providers must travel to their clients as planned [3]. Clearly, traffic delays impinge on their productivity and economic efficiency regardless of their location [3].

Another factor which is always interrelated with traffic light is the pollution issue. As the number of road users constantly increases, those vehicles waiting in the traffic light junction will generally produce greenhouse gases such as carbon dioxide, carbon monoxide etc. This directly contributes towards the air pollution issues since it's an ongoing activity through the year.

One of a congested road is shown in Fig. 1. Some of the road users are wearing mask in the afford to preventing them to inhale the carbon dioxide fumes.



**Fig. 1: Motorist queuing in a certain road during peak hours.**

The fumes generated by vehicles are impossible to be eliminated in roads, but it will be possible to reduce if better traffic flow is established in the city roads. Such fumes are not only dangerous but it will

affect the eco system of the world in the long run. The example of vehicles generating fumes is as shown in Fig. 2.



**Fig. 2: Greenhouse gases produce by vehicle during peak traffic hours**

## 2 Limitation of the conventional technology

The conventional traffic light system is build with only one sensor placed at the road end before the junction. The sensor is usually visible as a black rectangular line as shown in Fig. 3.



**Fig. 3: The magnetic loop sensor placed at the road end before the junction.**

The usage of one sensor is not practical for all applications. Such a practice creates an inefficiency system because with only one sensor to detect the presence of a vehicle approaching the road end. If the sensor is activated, a signal will be send to the traffic light controller to notify the availability of the vehicle. In the case of the sensor malfunction or faulty, the traffic light control system will operate in a pre programmed mode while the presence of a vehicle could not be detected at all time.

In big cities, traffic flow is high especially during peak hours [4, 5]. It is quite common for the traffic police to arrange the traffic flow as shown in Fig. 4. During the usage of a traffic police, the road users will be confused by the traffic light indicators as well as the direction given by the traffic police. In such scenario, the risk of traffic police increases when standing in the middle of the traffic light intersection which may lead to the accident in the traffic light junction.



**Fig. 4: Traffic police arranging the traffic flow in Malaysia**

During peak hours the traffic police will be present at the traffic light junctions to direct the traffic to ensure smoothness to the road users. The traffic police will be at the center of the junction and give direction to the road users and at the same time the traffic light will operation as programmed. In most cases, the road users will concentrate on the traffic light sequence from a distance away and it is to their priority. Some confused driver will end up in an unexpected accident with other drivers in the same lane and there are many cases report on accidents which involve traffic police as a result of confusion to the drivers.

The inefficiency of conventional traffic light system leads to traffic congestion that occurred every day. Fig. 5 shows that an old lady pass through the traffic junction while a volume of vehicles are waiting the traffic light. Such a scenario is very common in the city roads especially during peak hours.



**Fig. 5: Traffic light junction during peak hours**

Traffic flow during peak hour is difficult to be predicted and it's not an easy task to control especially when the number of vehicles is beyond the capacity. In some worse cases, the road user will tend bypass the traffic regulation due to long queues and long waiting hours. A situation of traffic congestion in a city is shown in Fig. 6.



**Fig. 6: Traffic congestion in a city**

### 3 Traffic light controller

The traffic system requires a stable controller to operate at all times. The common technology behind the traffic light controllers are programmable logic controllers (PLC). The PLC is an intelligent device which is capable to work without human interventions at all times regardless of duration and weather conditions [4, 5].

For generation PLC is being used as the heart of the traffic light system. The traffic light sequence is preprogrammed in the PLC for the display of the traffic light indicators. The PLC controllers are reliable and durable for such an application especially into extensive automated operations.

There are even some sophisticated controllers used for traffic light controlling. The computer based controllers are at certain traffic light junctions to operate with some intelligent. The problem with computer based controllers is the cost and the durability of the system. The computer based system requires additional supporting components due to the use of high voltage and current for the display system [6].

As many new technologies are being explored within the resources of traffic light controllers, the best practice is the PLC. With new technological PLC available in the market, intelligence is added to its conventional operations to make it even more efficient. Such an approach is always an ongoing process in ensuring the smoothness of the traffic

flow. As the most of the controllers are common, it limits the capability of the operation during peak hours.

## 4 Traffic light programming methods

There are two methods in programming the traffic light controllers placed on a certain junctions. The most common method is sequencing method, whereby the traffic light system is designed to operate according to a pre-programmed sequence without any consideration of real time behaviour. The second method is sensor based controller which response to the pre-programmed timer based on current demand on a certain road junction.

### 4.1 Normal Sequence

Sequencing method is the most common programming method used in the conventional traffic light system. It consists of normal sequence or fixed-cycle during its operation. The block diagram for normal sequence is shown in Fig. 7. The traffic light system will operate according to the sequence from lane 1 to lane 2, followed by lane 3 and then repeat the cycle to lane 1.



**Fig. 7: Block diagram of normal sequence programming**

Such a programming technique is considered passive for the controller used. The traffic light operation is typically based on the preprogrammed sequence only. Even when there is no vehicle presence in a certain junction, the traffic lights indicate its respective colours. This programming approach waste lot of time on the waiting or queuing for the road users.

### 4.2 Sensor Based Controller

The most common technology used is the magnetic loop detection sensor. The sensor will be connected to the traffic light controller for the changes in the sensing and the traffic light controller will respond accordingly.

A magnetic loop sensor is placed in the road end before the junction. Typically, a sensor includes a loop of wire imbedded in the pavement and detects the presence of a vehicle over the loop by the change of the inductance of the loop [2].

Such a system typically relies on the sensor detection. There are many technology and method is being tested and used around the world in the afford of detecting or tracking vehicles on a certain road junction. There is some sensor which is unable to detect small vehicles like motorcycle. In most cases there will be possibilities for the sensor to detecting vehicles in various sizes including motorcycle [7 - 9].

The use of presence detectors permits avoidance of cycling the traffic lights to green for the following junction if no vehicles are waiting during the red [2]. This method allows the user to move in and out on a certain traffic light junction as short as possible. Anyway the system is not efficient during peak hours, since the detection of the sensor will only indicate the presence of a vehicle not the number of vehicles.

The sensor placement for the conventional traffic light system is shown in Fig.8.

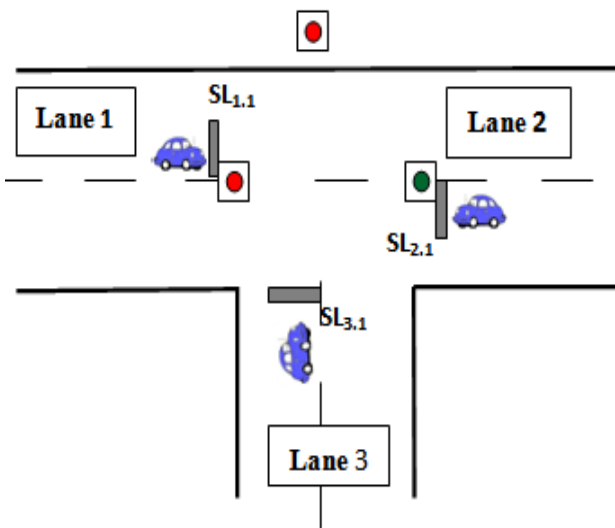

**Fig. 8: Sensor placement for the conventional traffic light system**

The block diagram conventional traffic light system is as shown in Fig. 9.

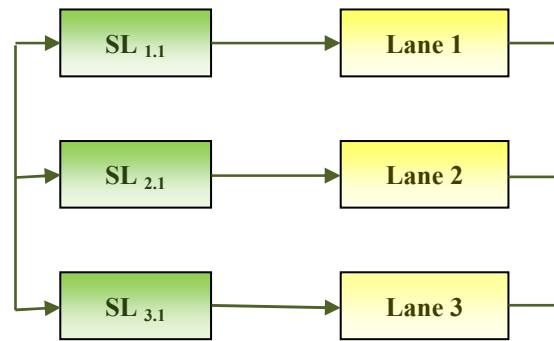

**Fig. 9: Block diagram for sensor in each road end before junction**

The programming method is as given in the flow chart in Fig. 10. The programming flow chart for lane 1, lane 2 and lane 3 is the same. The program is written in sequence based on the number of junctions. The timing for each sequence is prefixed based on the time study made.

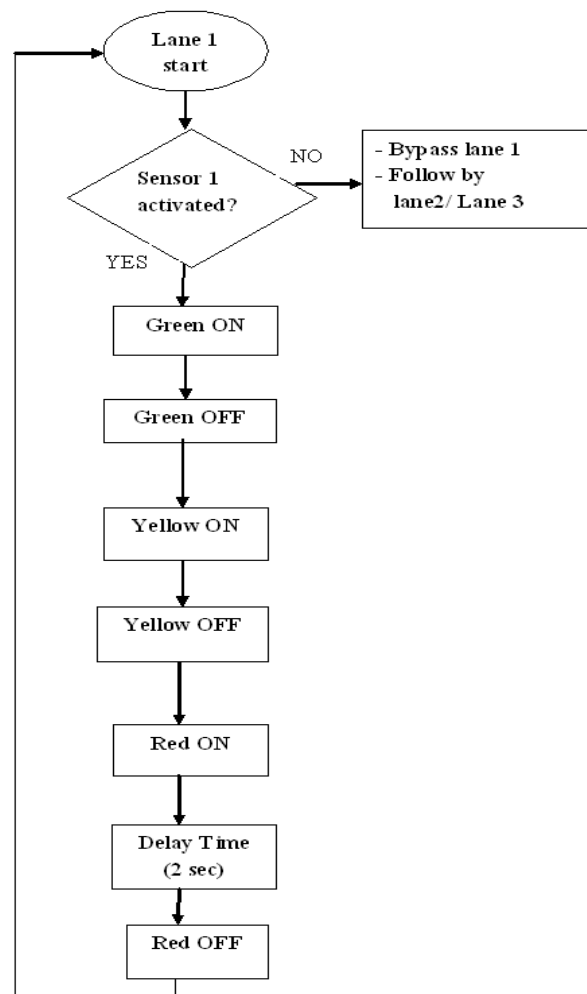

**Fig. 10: Flow chart for sensor 1 in lane 1**

## 5 Self-Algorithm Traffic Light System

### 5.1 Sensor Placement

The self-algorithm traffic light system is made up by combination of the sequencing programming method and the sensor based programming method in the PLC as the main controller. The self-Algorithm traffic light system requires additional sensors for better sensing for the vehicles coming in and out of on a certain junction.

The additional sensors placed in the proposed system would enable the traffic light controller to detect more accurate movements of a vehicle moving in and out of a certain junction on real time basis. The proposed method is designed with 3 additional sensors and 1 conventional sensor. The additional sensor is placed to measure and detect the presence of vehicle approaching a certain junction much better than the conventional traffic light system. The new system also enables the controller to detect the vehicle travelling out of each possible junction for detection during peak hours.

Sensor indicated as  $SL_{1,2}$  is placed distance away from the conventional located sensor indicated as  $SL_{1,1}$  at the road end before the junction in the same lane. Another sensor ( $SL_{1,3}$ ) is placed next to the  $SL_{1,1}$  in the opposite lane. Sensor  $SL_{1,3}$  is designed to be used to detect the queue for the U turn lane during peak hours. The sensors placement for self-algorithm traffic light system is shown in Fig. 11.

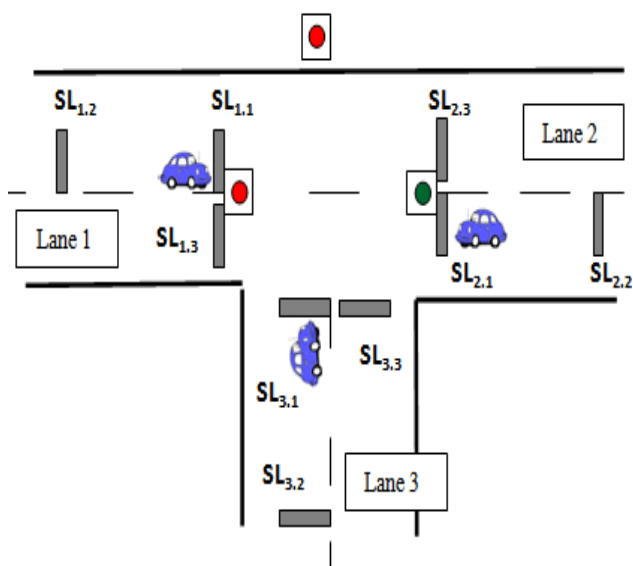

**Fig. 11: Sensors placement for self-algorithm traffic light system**

### 5.2 Function of Sensors

Sensors are the best device to use in an automation system especially for remote locations where human excess is limited [4, 5].  $SL_{1,1}$  is used to detect the presence of vehicles in particular junction which will determine the priority of the traffic light sequence based on first come first serve. When  $SL_{1,1}$  is in deactivated condition, the traffic light sequence will not turn the light to green for lane 1.

$SL_{1,2}$  is placed a distance away from  $SL_{1,1}$  for detecting a series of vehicles queuing on lane 1. The conventional traffic light system only detects the presence of vehicle on a certain junction without consideration of the number of vehicles queuing in that lane.

The sensor  $SL_{1,2}$  and sensor  $SL_{1,1}$  is placed in an appropriate distance in measuring the number of vehicles in that lane and the signal will be generated to the traffic light controller to vary the timing of green light by demand. Such a practice could result in smoothness in the traffic operation especially during peak hours.

The equation is preprogrammed in the self-algorithm controller to respond according to real time changes. The block diagram of the sensor detection is as shown in Fig. 12.

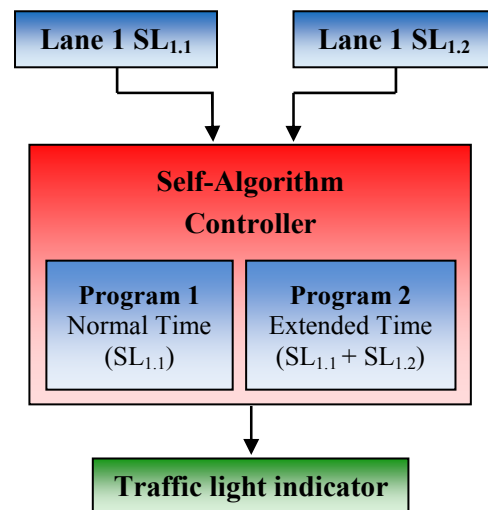

**Fig. 12: The block diagram for sensor detection and controller in lane 1**

The programming flow chart for lane 1 is as shown in Fig.13.

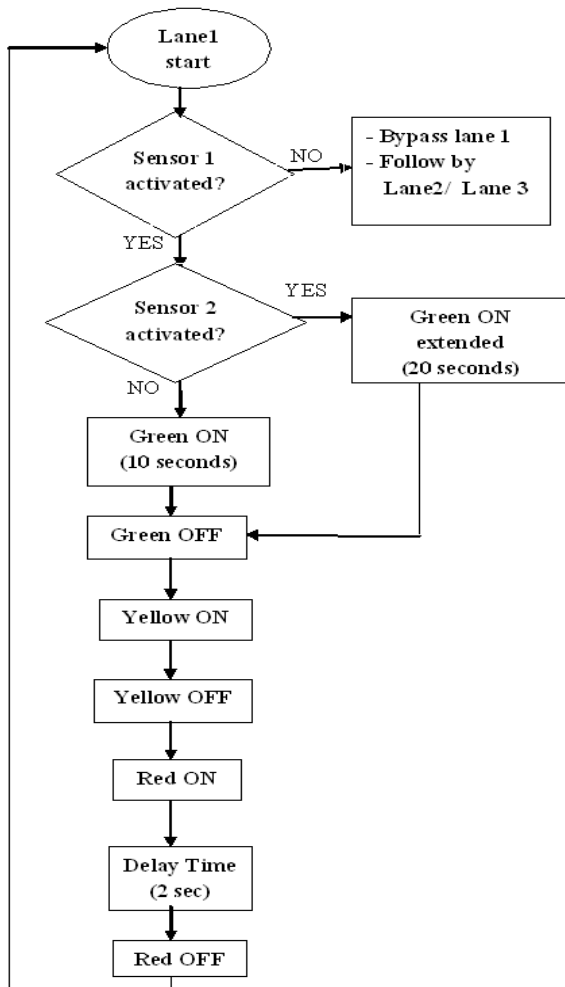

Fig. 13: Programming flow chart for lane 1

As simple test bed for the developed prototype of self-algorithm traffic light system is tested with the new placements of sensor. The first condition is similar to the conventional traffic light system which is when the  $SL_{1,1}$  is activated, the timing for the green colour traffic light indicator in certain junction will turn on for a period of approximately 10 seconds. The condition is calculated as shown in equation 1:

Assume that sensor  $SL_{1,1} = 10$  seconds

$$SL_{1,1}(t) = 10 \text{ s} \tag{1}$$

The second condition is when both  $SL_{1,1}$  and  $SL_{1,2}$  is activated, the timing for green colour traffic light indicator will be extended for that particular junction for a period of approximately 30seconds. The condition is calculated as shown in equation 2:

Assume that sensor  $SL_{1,1} = 10$  seconds  
 sensor  $SL_{1,2} = 20$  seconds

$$SL_{1,1}(t) + SL_{1,2}(t) = 10 \text{ s} + 20 \text{ s} \tag{2}$$

The timing for sensor 1 and sensor 2 is preprogrammed in the traffic light controller. The value for  $SL_{1,2}$  is calculated based on the distance of the sensor  $SL_{1,2}$  and  $SL_{1,1}$  is placed.

Another set of sensors will be intergraded during the sensing of  $SL_{1,1}$  and  $SL_{1,2}$ . When the traffic light controller is detecting the changes from  $SL_{1,1}$  and  $SL_{1,2}$ , the system will scan or read thru 3 more additional sensor values to decided on the timing assigned to turn on the green indicator on a certain lane. The additional sensors are sensor  $SL_{1,3}$ ,  $SL_{2,3}$  and  $SL_{3,3}$ . The programming block diagram for all 5 sensors is as shown in Fig. 14.

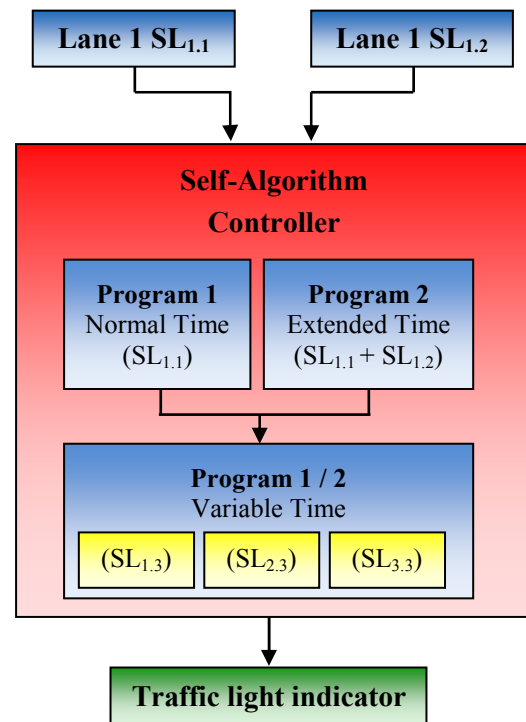

Fig. 14: The block diagram for sensor detection and controller in lane 1 with the outgoing lanes

The condition with the other 3 sensors detected is calculated as shown in equation 3:

Assume that:

- sensor  $SL_{1,1} = 10$  seconds
- sensor  $SL_{1,2} = 20$  seconds
- sensor  $SL_{1,3} = -10$  seconds (if not detected)
- sensor  $SL_{2,3} = -10$  seconds (if not detected)
- sensor  $SL_{3,3} = -10$  seconds (if not detected)

$$SL_{1,1}(t)+SL_{1,2}(t)+(SL_{1,3}+SL_{2,3}+SL_{3,3})(t) = 30 \text{ s} \quad (3)$$

The flow chart for sensor 1, sensor 2 and sensor 3 is shown in Fig.15.

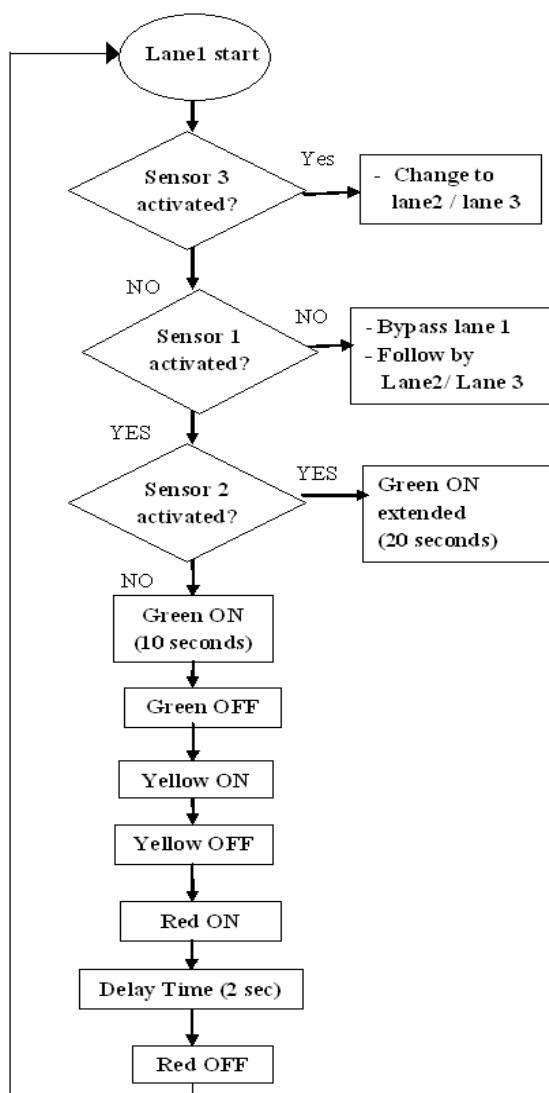

Fig. 15: Programming flow chart for lane 1with the other out going lanes

### 5 Comparison between conventional traffic light system and self-algorithm traffic light system

There are some factors and difference between the conventional traffic light system and the self-algorithm traffic light system. The most important factors is shown side by side in Table 1.

Table 1: Comparison between conventional traffic light system and self-algorithm traffic light system

Functions/ Factors	Conventional Traffic Light	Self-Algorithm Traffic Light
Traffic Police during peak hours	Required	Not Required
Variable time	No	Yes - By normal Sequence - By demands / Conditions
Lane priority	No	Yes
Traffic congestion	High Probability	Less Probability
Control	Same - PLC	Same - PLC (Self Algorithm)
Costing	Cost for only 1 sensor	Cost for 3 sensors

### 6 Conclusions

The self-algorithm traffic light system is designed to minimize the waiting time at a certain traffic light junction for road users. By using the sensor based controlling method, traffic light system will response to the real time demands as changes are detected. 2 different timing are preprogrammed in the controller and as changes is detected the controller will response accordingly. Therefore enhance the smoothness and increases the efficiency of the traffic flow especially during the peak hours in urban areas. Furthermore, the possibility of traffic congestion will be reducing.

The new sensor based controller method is capable of counting the total number of vehicles entering a certain junction and exiting from a certain junction on real time basis. Based on this detection, the PLC will trigger the traffic light indicators according to real demand. The new method should also be easy for further enchantment of traffic light system in ensuring smoothness of traffic flow especially during peak hours.

The system can replace the use of human in any kind of traffic flow control operation. With the



self-algorithm traffic light system, no traffic police is required to arrange the traffic flow. The implementation cost is invaluable to the efficiency and usefulness of the system towards mankind. The system can also reduce the number of accident that could occur in the traffic light junction.

Self-algorithm traffic light system will contribute to reduce the greenhouse gases from those vehicles in traffic junction. The shorter the waiting time produce less greenhouse gases. In other point of view, road users can save the petrol cost by minimizing the waiting time.

## 7 Acknowledgements

This paper describes research that is ongoing at the Faculty of Electronics and Computer Engineering to develop a self-algorithm traffic light controllers for heavily congested urban in support of the humanitarian community. This work is part of the project intelligent traffic light system and was funded by Universiti Teknikal Malaysia Melaka.

Authors would like to thank all organizations and friends concerned for their sincere encouragement, support and assistance in the development of self-algorithm traffic controllers for heavily congested urban route. The authors would like to take this opportunity to also thank them for their contributions in defining and helped to improve the system and services towards a better system. The authors also would like to specially thank:

Ministry of Works Melaka (JKR)  
Melaka Road Safety Department (JKJR)

## 8 References

- [1] Marco Wiering, Jelle van Veenen, Jilles Vreeken and Arne Koopman, Intelligent Traffic Light Control, Intelligent Systems Group, Institute of Information and Computing Sciences Utrecht University Padualaan 14, 3508TB Utrecht, The Netherlands, July 9, 2004.
- [2] Burhan Bayraktaroglu, Plano, Tex., Traffic Light Control System and Method, Google Patent, Texas Instrument Incorporated, Patent number: 4908614, March 13, 1990.
- [3] Avram Robinson-Mosher, Christopher Egner, Learning Traffic Light Control Policies.
- [4] S. K. Subramaniam, V. R. Gannapathy, S. A. Anas, A. B. M. Diah, M. K. Suaidi, and A. H. Hamidon, Intelligent and Self Control Safety Traffic Light System for Road Constructions, Proceedings of 8th WSEAS International Conference on Circuits, Systems, Electronics, Control and Signal Processing, December 14-16, 2009, pp. 53-58.
- [5] V.R Gannapathy, S.K Subramaniam, A.B Mohamad Diah, M.K Suaidi and A.H Hamidon, Risk Factors in a Road Construction Site, Proceedings of the World Academy of Science, Engineering and Technology 46, 2008, pp. 640 – 643.
- [6] Stela Dinescu, Anamaria Giurgiulescu, Possibilities of implementing a monitoring system for road transport using a dimensions basis approach, WSEAS TRANSACTIONS on SYSTEMS and CONTROL, Issue 4, Volume 5, April 2010, pp. 195 – 204.
- [7] Min-Yu Ku, Chung-Cheng Chiu, Hung-Tsung Chen and Shun-Huang Hong, Visual Motorcycle Detection and Tracking Algorithms, WSEAS TRANSACTIONS on ELECTRONICS, Issue 4, Volume 5, April 2008, pp. 121 – 131.
- [8] C.C. Chiu, C.Y. Wang, M.Y. Ku, and Y.B. Lu, Real-Time Recognition and Tracking System of Multiple Vehicles, IEEE International Conference on Intelligent Vehicles Symposium, 2006, pp. 478 - 483.
- [9] J.J. Tai and K.T. Song, Automatic Contour Initialization for Image Tracking of Multi-Lane Vehicles and Motorcycles, IEEE International Conference on Intelligent Transportation Systems, Vol. 1, 2003, pp. 808 - 813.

## 10 Biographies



Siva Kumar Subramaniam received his Diploma in Electronics Engineering from Politeknik Ungku Omar, Malaysia in 2002. He then graduated with a Bachelor Degree in Electronics Engineering

(Industrial Electronics) from KUTKM Malaysia in 2006 and his Master studies in Electronics Engineering in the same institution in 2009 which is now known as Universiti Teknikal Malaysia, Melaka. Engr. Siva Kumar is working as a Lecturer in the same organization ever since of graduating. Since his keen interest in industries matters and strong support from the university, the author is involved in the development of the industrial based application such as monitoring systems, automation for industries consumer electronics and control base applications. Engr. Siva Kumar has a few collaboration with industries in accomplishing a number of research projects and consultancy works in Malaysia for the past few years. He was involved in such projects from his basic degree whereby he won several medals in both National and International competitions around the world. Engr. Siva Kumar has also filed for six patents for his inventions through his career. Apart from research works with industries, Engr. Siva Kumar also supervises Diploma and Degree students for their final year projects within the same institution.



Mazran Esro graduated his Bachelor Degree in Electronic Engineering from UTM in 2001. After graduation, he started his career as a research Officer at Gas Technology Centre (GASTEK) in UTM for one year. At

GASTEK, he has been involved in research related to NGV control technologies for vehicle control system. One of the controller is the gas valve control

using Motorola HC11 microcontroller. By end of 2002, he was offered a job as a management trainee at Sime Sembcorp Engineering Sdn Bhd, a subsidiary company of Sime Darby. 1 year later, he moved to Universiti Kuala Lumpur (UNIKL-BMI) as an assistant Lecturer. He taught c programming, C++ and microprocessor system for diploma student. He then moved to KUTKM (now known as UTeM) after one year as a tutor with a package to further study in Masters Degree. He obtained his masters Degree from RMIT University, Melbourne Australia by end of 2006. Then he served as a Full Time Lecturer at Electronic & Computer Engineering Faculty, Universiti Teknikal Malaysia Melaka. With 4 years of experience in teaching and research at UTeM, he was then promoted as a Senior Lecturer in year 2011. Besides his academic qualification, Mazran Esro also has been Certified as an IPC-A-610 Trainer or Class A Instructor by Master Trainer from Surface Mount Circuit Board Association (SMCBA) Melbourne Australia. Besides IPC, he also have professional certificate as the Man & Tel Embedded Router Certified Trainer. Besides teaching and learning activities in the faculty, he is actively involved in Research and development with his research team and has achieved numerous awards from research exhibition competition in the national and international level.



Aw Fang Li was born in 2 October 1987. She graduated with a Bachelor Degree in Electronics Engineering (Wireless Communication) from Universiti Teknikal Malaysia Melaka (UTeM) in 2011. As an

undergraduate student she was actively involved in many research and project activities within the university. She builds her expertise in the field of intelligence in control system as well as electronics hardware development. During her final year project she has collaborated with an industry player to further enhance the work she was involved in the afford to benchmark it to the industrial standard. For her afford she was awarded a Gold medal and Industrial Award in one of the competition held in the University. Aw Fang Li's final year project was also awarded the best project in the Faculty of Electronics and Computer Engineering, UTeM.