

# Simulation and Analysis of Electromagnetic Transient Characteristics of Controllable Reactor of Transformer Type

TIAN MINGXING, ZHAO QIANRU, YIN JIANNING, LIU YIBIN

Automation and Electrical Engineering

Lanzhou Jiaotong University

Lanzhou Gansu

CHINA

cicizqr1991@126.com

*Abstract:* This paper analyzed the winding construction of Controllable Reactor of Transformer Type (CRT), based on the duality theory a new transient model of CRT is proposed. It can reflect the electric circuit coupled with magnetic circuit correctly. Fitting the magnetization curve with the function fitting method and the simulation results prove the accuracy of the model. Proposing divide CRT's working process into operating process and grade-changing process. And analyze and research the transient processes of the two processes respectively. According to the transient model build CRT no-load switching-in mathematical model, do simulation research with ATP-EMTP, analyze the phenomena of magnetizing inrush current in operating process. And analyze current of each winding in grade-changing process, the simulation results verify the correctness of the model and analyze the transient characteristic of CRT.

*Key-Words:* Controllable Reactor of Transformer Type; Transient model; ATP-EMTP; Magnetizing inrush current; Transient characteristic

## 1 Introduction

With the increasing level of power line voltage, the EHV power and high surge impedance loading compact transmission line is developing very fast. But this leads to a critical problem -- Ferranti effect. In order to guarantee the security, reliability, stability of the power grid, reactive power compensation device must be used to achieve the purpose of reactive power balance and voltage control [1]. In recent years, CRT (Controllable Reactor of Transformer Type) has been studied as a new type of controllable reactor. It has the characteristics as fast and smooth adjustment and small harmonic current. CRT is not only able to provide real-time solution to the problem of Ferranti effect but also independent from an over reliance on power electronic technology.

To study the transient process of CRT, the establishment of an accurate equivalent model is necessary. The reference [1] analyzed the working characteristics of the CRT by establishing the polygon equivalent circuit model, this model can reaction

coupling between the windings, but ignored the core saturation characteristic, which make the results of transient process is not accurate, and the model is not only complex, also bring difficulties for the design of CRT. The reference [2] analyzed the operation mode of CRT by establishing the equivalent circuit model of many parallel branches, but it ignored the leakage resistance and resistance between the windings. So it make the calculation results of control winding current is erroneous. And this model did not consider the core saturation characteristic, thus it is not suitable for transient study. The reference [3] analyzed the equivalent circuit model of multi-winding transformer. And the ray form equivalent circuit model is proposed. But this model ignored the coupling effect and core saturation characteristic. So this model not only does not apply to transient study but also reduce the accuracy of the calculation result of current. The reference [4] established trapezoidal equivalent circuit model by using duality principle. The model considered the electromagnetic coupling

between the windings and the alternating magnetic flux leakage, but ignored the core saturation characteristic. Therefore, this paper based on the structure of CRT, a new equivalent circuit model for the practical application is proposed. In this model, magnetic leakage flux and the core saturation are considered. Besides, the coupling relation between electric circuit and magnetic circuit is reflected.

The reference [5] analyzed the transition process of the CRT, and came to a conclusion that there is zero transient in CRT on the premise of ignoring the excitation branch. This paper study on the transient process of CRT under the same condition but couldn't get same conclusion.

In addition, this paper conducts a detailed study of the transient process of CRT. And obtain the transient current of each winding.

## 2 CRT basic operation principle

CRT is mainly composed of high voltage work winding, low voltage control winding and thyristors, the basic operation principle is shown in figure 1.

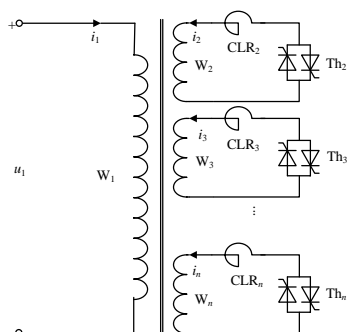

Fig.1 Basic circuit diagram of CRT

In figure1,  $W_1$  is work winding,  $W_2$ ,  $W_3$ , ...,  $W_n$  are control windings,  $Th_2$ ,  $Th_3$ , ...,  $Th_n$  are anti-parallel thyristors,  $CLR_2$ ,  $CLR_3$ , ...,  $CLR_n$  are current limiting inductors,  $u_1$  is work voltage. When put the voltage on work side, we can adjust reactive power capacity by control the size of conduction angle of the anti-parallel thyristors.

As the figure 1 shows, CRT is multi-winding transformer whose control windings are work in the state of short-circuit in sequence.

The core winding structure of CRT is shown in figure 2. The outermost layer  $W_1$  is

work winding,  $W_2$ ,  $W_3$ ,  $W_4$  which close to the core are control windings. The core structure is symmetrical. So analyze the right half of core.

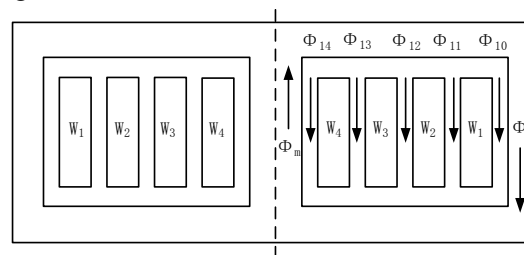

Fig.2 Core winding structure of CRT

In figure 2,  $\Phi_m$  is half of main magnetic flux of core,  $\Phi_0$  is magnetic flux of core yoke,  $\Phi_{11}$ ,  $\Phi_{12}$ ,  $\Phi_{13}$ ,  $\Phi_{14}$ ,  $\Phi_{15}$  are leakage magnetic flux between windings.

## 3 The transient model of CRT

### 3.1 Magnetic circuit model

According to the figure 2 can get the magnetic circuit model of CRT which is shown in figure 3.

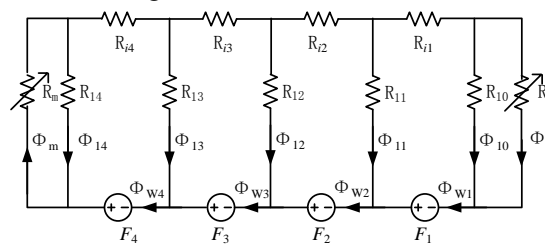

Fig.3 Magnetic circuit model of CRT

In figure3,  $F_1$ ,  $F_2$ ,  $F_3$ ,  $F_4$  are magnetomotive force of each winding respectively,  $R_m$ ,  $R_0$  are resistance of core and core yoke respectively,  $R_{10}$ ,  $R_{11}$ ,  $R_{12}$ ,  $R_{13}$ ,  $R_{14}$  are resistances of leakage magnetic flux between the windings,  $R_{11}$ ,  $R_{12}$ ,  $R_{13}$ ,  $R_{14}$  are resistances of core between the leakage magnetic circuit.

According to Gauss theorem in magnetic field and Ampere cycle theorem, a magnetic circuit equation is built as follows (Because the resistance of core between the leakage magnetic circuit is far less than excitation reluctance, so here is ignored):

$$\begin{cases} F_1 + F_2 + F_3 + F_4 - \phi_m R_m \\ + \phi_0 R_0 + \phi_{10} R_{10} + \phi_{11} R_{11} + \\ \phi_{12} R_{12} + \phi_{13} R_{13} + \phi_{14} R_{14} = 0 \\ N_1 i_1 + N_2 i_2 + N_3 i_3 + N_4 i_4 \\ = F_1 + F_2 + F_3 + F_4 \\ \phi_m = \phi_0 + \phi_{10} + \phi_{11} + \phi_{12} \\ + \phi_{13} + \phi_{14} \end{cases} \quad (1)$$

### 3.2 Circuit model

According to the formula (1) as well as the duality principle of circuit and magnetic circuit, the trapezoidal equivalent circuit model of CRT which is shown in figure 4 is built.

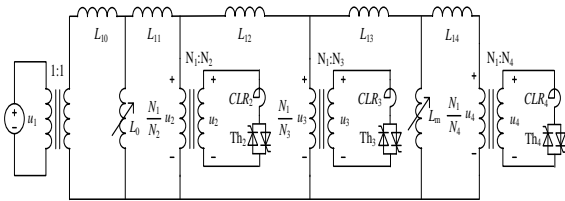

Fig.4 Circuit model of CRT

In figure 4, the nonlinear inductance  $L_m$ ,  $L_0$  are the inductance of core and core yoke respectively, the linear inductance  $L_{10}$ ,  $L_{11}$ ,  $L_{12}$ ,  $L_{13}$ ,  $L_{14}$  are the leakage inductance of each winding respectively.

### 3.3 The core model

The magnetization curve of 30Q130 type grain-oriented magnetic steel sheet which is published by Wuhan Iron and Steel Mining Company is shown in figure 5.

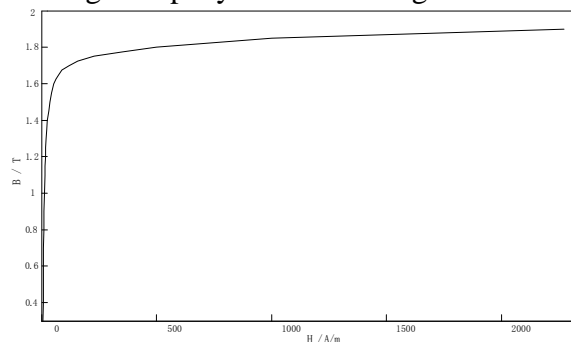

Fig.5 Magnetization curve of grain-oriented magnetic steel sheet

For the convenience of calculation and high precision, function fitting method is adopted to build the core model of CRT. By contrasting the fitting results of some common functions, the paper, describes the nonlinearity of core in the method of

piecewise fitting and does tests with MATLAB which is shown in figure 6. The simulation result proves that the fitting method adopted in this paper is able to describe the characteristic of nonlinearity of core model.

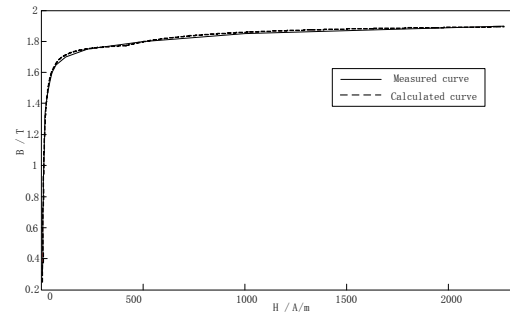

Fig.6 The magnetization curve of Measured and calculated

And the mathematical model of core is shown in formula (2):

$$\begin{cases} B = -10.21/H + 1.797 & 0 \leq H \leq H_m \\ B = 1.923 * e^{-33.95/H} & H_m < H \leq H_{max} \end{cases} \quad (2)$$

## 4 The transient process of CRT

The working process of CRT can be subdivided into operating process and grade-changing process. The operating process is no-load input the power grid. The grade-changing process is working side put into the power grid and control windings work as progressive single branch mode [1].

### 4.1 The operating process

The research of operating process, mainly consider the no-load closing process. The voltage equation for CRT is shown as below:

$$\begin{cases} u_1 = L_{10} \frac{di_1}{dt} + R_1 i_1 + N_1 \frac{d\psi_m}{dt} \\ \psi_m = f(i_m) \\ i_1 = i_m \end{cases} \quad (3)$$

And:

$$\frac{d\psi_m}{dt} = \frac{d\psi_m}{di} \cdot \frac{di}{dt} = k \frac{dB}{dH} \cdot \frac{di}{dt} = k\mu_m \frac{di}{dt}$$

So:

$$R_1 i_1 + (L_{10} + k\mu_m N_1) \frac{di_1}{dt} = u_1(t) \quad (4)$$

Set  $L = L_{10} + k\mu_m N_1$ ,  $R = R_1$ , and

$$u_1(t) = U \cos(\omega t + \alpha).$$

The formula (4) can be simplified into:

$$\frac{di_1}{dt} + \frac{R}{L}i_1 = \frac{U}{L} \cos(\omega t + \alpha)$$

Set the switch for closing moment  $t=0$ ,  $i_1(t)$  should meet the initial condition:

$$i_1|_{t=0} = 0$$

Get  $i_1(t)$  solution consists of two parts: one is steady state component part, the other is transient state component, as follows:

$$i_1(t) = \frac{U}{R^2 + \omega^2 L^2} [R \cos(\omega t + \alpha) + \omega L \sin(\omega t + \alpha) - e^{-\frac{R}{L}t} (R \cos \alpha + \omega L \sin \alpha)] \quad (5)$$

We can get to know from the formula (5), steady current is a cosine function, the transient current decreases gradually and tends to zero eventually. In order to get the further reduction, we make:

$$\begin{cases} \cos \phi = R / \sqrt{R^2 + \omega^2 L^2} \\ \sin \phi = \omega L / \sqrt{R^2 + \omega^2 L^2} \end{cases}$$

And put into formula (5), so

$$i_1(t) = \frac{U}{\sqrt{R^2 + \omega^2 L^2}} [\cos(\omega t + \alpha - \phi) - \cos(\alpha - \phi) e^{-\frac{R}{L}t}] \quad (6)$$

And  $\phi = \arctan(\omega L / R)$ .

$i_1(t)$  and  $u_1(t)$  have the same cycle, but the phase angle fall behind  $\phi \approx 90^\circ$ , so we can further reduction the formula (6) as follows:

$$i_1(t) = \frac{U}{\sqrt{R^2 + \omega^2 L^2}} [\sin(\omega t + \alpha) - e^{-\frac{R}{L}t} \sin \alpha] \quad (7)$$

Thus, the formula (7) is the mathematical model of CRT in no-load input power grid. As we can see from the formula, working current is mainly composed of two parts, one is the ac power sinusoidal component the other one is the dc component which is decreasing in the form of index. Besides, the value of working current is influenced by initial angle  $\alpha$  at input moment. It's not hard to see from the formula, the amplitude of the dc component is maximum when  $-\pi/2$ . As the magnetization curve is nonlinear, inrush

current is 4~6 times of rating.

In this paper, a 500 kV CRT for no-load switching-in simulation research is shown in figure 7.

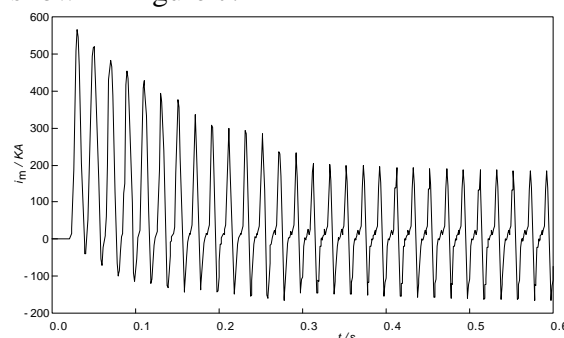

Fig.7 Excitation current of CRT

It is can be seen from the simulation results of figure 7, the transient process lasted 24 cycles, and inrush current attenuation in the form of index, the attenuation constant is associated with the degree of saturation of core, the reactance of the feature of CRT makes its attenuation slower. And the inrush current reached 4.92 times of rated current. The spire of the wave shows that there is higher harmonic component in working current.

## 4.2 The grade-changing process

Take advantage of electromagnetic transient program ATP-EMTP to set up CRT simulation model. The basic idea of method to deal with various circuit components is use the differential equation to describe voltage and current relationships of various circuit components in the process of transition [7]. Based on the equivalent circuit model of CRT in figure 4, the simulation model is built.

The grade-changing process of CRT is control the thyristors action of each branch. Stipulated that put the control winding into work at the mode of progressive single branch. And use the trigger pulse to control each thyristors. Using the electromagnetic transient simulation software ATP-EMTP to simulate the grade-changing process and adapting the bidirectional thyristors Type-12 instead of reverse parallel thyristors. Select the TACS type 24 of the transient control system for each thyristors trigger pulse sequence. Factor which influencing the grade-changing process of transient response is the action moment for each branch of thyristors. Different actions

moment can lead to different initial voltage and different transient process. According to the above analysis, the current of each winding at zero moment and peak moment is simulated respectively as follows:

(1) The moments of thyristors switch-in are 0.505s, 0.515s, 0.525s, 0.535s (namely source voltage is zero points) respectively. The current simulation results are shown in figure 8.

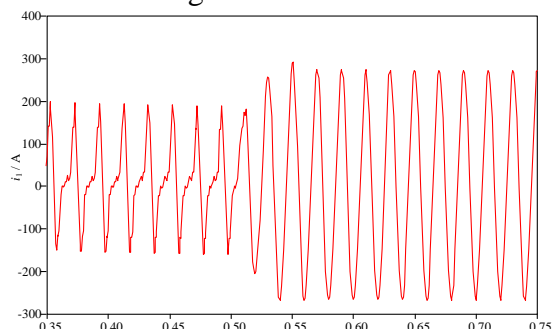

(a) The simulation waveform of  $i_1$

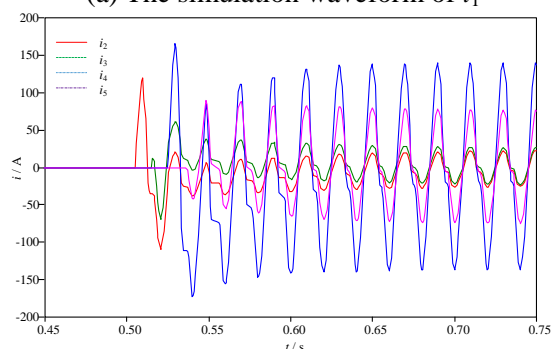

(b) The simulation waveform of each control winding current

Fig.8 The waveforms of current in zero time

As the figure 8(a) shows, the amplitude of  $i_1$  will increase when input each control winding. This is because CRT is controlled by the access of control winding to achieve the purpose of the reactive power balance and voltage control. As figure 8(b) shows, the control windings which have accessed to circuit will be affected by the access of subsequent control windings. And the amplitude of control current which have accessed to circuit is decreasing after the access of each subsequent control winding. This is because the existence of mutual leakage resistance between the control windings. When put all the control windings into circuit, each branch current also can reach steady state. But, at this point the transition period of grade-changing process is 0.23s.

(2) The moments of thyristors switch-in are 5s, 5.01s, 5.02s, 5.03s (namely source voltage is peak points) respectively. The current simulation results are shown in

figure 9.

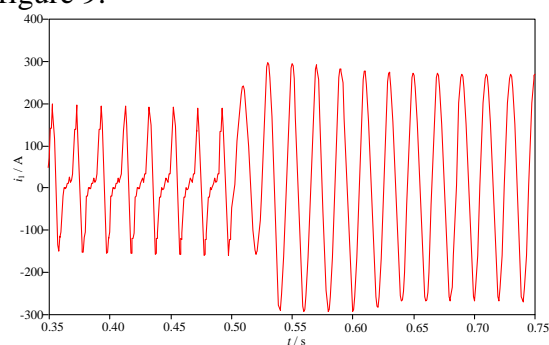

(a) The simulation waveform of  $i_1$

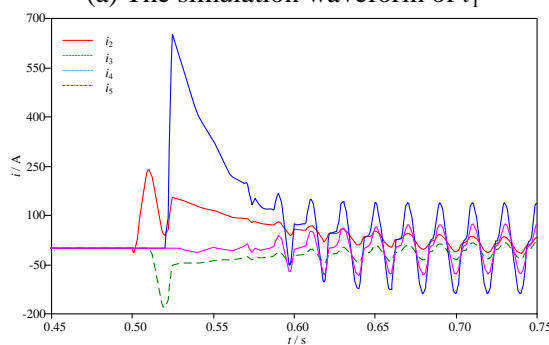

(b) The simulation waveform of each control winding current

Fig.9 The waveforms of current in peak time

As figure 9 shows, the rule of current waveforms is similar to the figure 8. But the highest transient current is four times in zero time. And at this point the transition period of grade-changing process is 0.21s.

Comparing figure 8(a) and figure 9(a), the transition process of the CRT is not affected by moment of thyristors switch-in and there is a transition process inevitably. Comparing figure 8(b) and figure 9(b), transient current in peak time is bigger than it in zero time. And it can affect the reliability and life of the CRT.

According to the characteristic of bidirectional thyristors, if remove the control signals, the thyristors will switch-off only when the current through the zero moment. So the time of switch-off is at the source voltage peak moment and there is no transient process.

## 5 Conclusions

There are many factors that influence the CRT transient response, different processes have different factors. This paper propose to divide CRT's working process into two independent but interactional processes: operating process and grade-changing process. And the transient processes of the two processes are analyzed

and researched respectively.

(1) The factors causing transient response in the operating process are the initial phase angle of supply voltage at the moment of access and the nonlinearity characteristic of the core. No matter which initial phase angle we adopt, the transient process must inevitably exist. But, when the initial phase angle is  $-\pi/2$ , the instantaneous value of inrush current reaches maximum.

(2) The factor causing transient response in the grade-changing process is the conduction angle of thyristors. The former control windings accessed could be affected by the latter control windings accessed, which make the decrease of branch current amplitude with the accesses of each latter control winding but intensive instantaneous current with each input. And, whatever the conduction angle of thyristors is, the transition process always exists.

(3) The exit process of CRT is controlled by anti-parallel thyristors in series at control windings. Therefore, if the control signal is removed, the CRT will not be turned off unless zero-cross current appears. And there is no transient process.

#### References:

- [1] TIAN Mingxing. *Basic Theoretical Research on Controllable Reactors of Transformer Type*, Xi'an Jiaotong University, 2005.
- [2] TIAN Mingxing. Operation Mode of a Controllable Reactor with Multiple Parallel Branches, *Transactions of China Electro Technical Society*, Vol.12, No.21, 2006, pp.21- 25.
- [3] TIAN Mingxing, Li Qingfu. Polygon Type Equivalent Circuit Model of Multi-Winding Transformers, *Journal of Xi'an Jiaotong University*, Vol.6, No.38, 2004, pp.636- 640.
- [4] Jian Wang, Arthur F. Witulski. Derivation Calculation and Measurement of Parameters for a Multi-winding Transformer Electrical Model, *IEEE, APEC, Dallas, TX USA*, No.1, 1999, pp.220-226.
- [5] TIAN Mingxing, LI Qingfu. Calculation and Simulation of a Controllable Reactor of Transformer Type, *Journal of Xi'an Jiaotong University*, Vol.8, No.38, 2004, pp.820-823.
- [6] ZHENG Weijie, ZHOU Xiaoxin. Equivalent Electro-magnetic Transient Model Based on Dynamic Reluctance for Magnetically Controlled Shunt Reactor, *Proceeding of the CSEE*, Vol.4, No.32, 2011, pp.1-6.
- [7] LI Xuan, YE Guoxiong, WANG Xiaoqi, et al. Transient Characteristics of 1000kV Capacitor Voltage Transformer Based on ATP-EMTP, *High Voltage Engineering*, Vol.9, No.34, 2008, pp.1850-1855.
- [8] TANG Xiaoling, LI Minzu, LIU Jingyuan, et al. Simulation and Analysis of Transient Characteristics of Capacitor Reactive Power Compensation by Adjusting Voltage with Thyristors, *High Voltage Apparatus*, Vol.1, No.45, 2009, pp.57-61.
- [9] DUAN Liyong, WANG Chengmin, ALEXANDROV G. N.. Research on the Bidirectional Control Principle of Reactive Power Based on a Transformer Type Controllable Shunting Reaction, *Power System and Clean Energy*, Vol.1, No.29, 2013, pp.9-15.
- [10] A. Nawikavatan, C. Thammart, T. Niyomsat. The Current Transformer Model with ATP-EMTP for Transient Response Characteristic and Its Effect on Differential Relays Performance, *IEEE, Advances in Power System Control, Operation and Management (APSCOM 2009)*, Hong Kong, China, 2009, pp.1-6.