

Impact of an internal polymeric liner on the fatigue strength of pressure vessels under internal pressure

M.A. Bennani ^{a,*}, Abdeslam El Akkad ^b, Ahmed Elkhalfi ^a

^a *Faculté des Sciences et Techniques de Fès, Maroc.*

^b *Département de mathématiques, Centre Régional des Métiers d'Education et de Formation Fès, Maroc.*

Abstract

This paper presents a new original idea about the fatigue strength of pressure vessels. It tries to examine the impact of the internal liner on the fatigue strength of pressure vessels. The liner is mainly used to protect the structure against corrosive products such as hydrocarbons. This study states that the installation of a super-elastic polymer coating can help to solve several problems related to pressure vessels. In addition to the protection against corrosion, this coating may contribute to the improvement of the fatigue strength of structures as well as the prevention of sudden leaks. Moreover, this paper has proposed two main examinations; the first is an attempt to compare different susceptible materials used as liners. Besides, parametric study is performed during the second examination with the previously selected material for the optimal thickness.

Keywords: pressure vessel; fatigue analysis; liner; coating; failure.

Introduction

Pressure vessels are widely used in industry for the storage and transport of liquids or gases. They can be defined as devices that work beyond atmospheric pressure. In the 19th century, the world experienced an unprecedented industrial revolution that conducted to the mass production of pressure vessels (tank, boiler ... etc.). These devices were dangerous and caused several damages. As consequently, it caused the legalization of regulatory and specialized standard for pressure vessels. While the most important are, the American Society of Mechanical Engineers (ASME-1915) and the Code for the Construction of Pressure Vessels not subject to the flame (CODAP). The pressure vessels are subject to several types of chemical or mechanical damage such as corrosion. The installation of internal liner functions as protection against the corrosive effect and warn leakage.

Pressure tanks are affected by some problems today despite the strict regulations undertaken recently. Many industrial incidents are caused by explosions of tanks containing flammable or leakage of petroleum products offshore, destroying ecological systems. Most of these structures have not been damaged due to under-sizing or poor design, but because of fatigue problems, which amplifies the presence of residual crack and lack of maintenance that sometimes are expensive or complicated. High cycle fatigue loading is one of the main mechanism that may lead to damage in pressure vessels, because damage occurs without exceeding the elastic limit. Theatrically speaking, the structure endures these charges, as they do not exceed the elastic limit, while in spite of the fact that these charges do not exceed this limit, the structure can undergo large damage due to fatigue.

This paper presents a study on the use of liner to increase the fatigue strength of pressure vessels. We propose to investigate the mechanical impact of the liner

and its durability against chemical attacks and other destructive phenomena.

The first part of the article provides the theoretical framework and the practical analysis to the phenomena and the tools used in this study. The second part presents the numerical model to assess the effectiveness of the method.

Pressure vessel liners-literature review

The liner is used in a large number of pressure vessels to protect metal structures against corrosion, but it is used in its metallic version in tanks and pipeline composite to seal the structure. This section presents some studies on topics concerning the liner or any related topic. A several scientific studies have dealt with the subject of the liner directly or indirectly. They study its mechanical impact, chemical or, in some cases, its use in the cured-in-place pipe (CIPP) for damaged pipelines.

A. Hocine et al. [1] conducted an investigative study on the type of materials used for the liner for composite cylinder with an internal liner. The study compares the resistance of three types of internal pressure to liner. The studied materials are HDPE (High Density Polyethylene), LLDPE (Light Polyethylene Low Density) and the combination of these two materials HDPE / LLDPE. Article approves the resistance of HDPE to high pressure by comparing it with other liners. F. Rueda et al. [2] conducted a study on recurring problem liners, including wrinkles and damage in the structure of the liner. The author points to the rapid depressurization as the main cause of the folds of the liner. He presents and uses a numerical model based on the method of unconventional finite elements, allowing the use of material law time-dependent behavior. Evoking the difficulty of reproducing the fold of the liner due to non-linear aspect, the material used is again HDPE (High density Polyethylene).

Y.T. Kim et al.[3] presents a comprehensive study on the impact of a cracked cylinder liner, which undergoes pure buckling forces and combines internal pressure; they use the finite element method to evaluate the stress at the crack tip. In addition, he conducted a parametric study to analyze the effect of the thickness of the liner and the effect of the size and the orientation of the crack on the buckling strength of the cylinder. We have deduced that the liner significantly improves buckling characteristics of a shell and one notes the influence of the thickness of the liner on the behavior of our thin cylindrical shell. On the other hand, it demonstrates the absence of the impact of circumferential cracks on the structure, but also the discovery of a low impact of a crack oriented at 30° .



Fig. 1. corroded pipe

Many authors have devoted [4], [5] and [6] to study the benefit of the liner for the protection of pressure vessels that have suffered the adverse effects of certain chemicals. The liners have the role to protect against the corrosion and abrasion. The liners might be found also in drinking water pipes, sanitary sewers, pressurized pipeline oil and gas and others, which allows the extension of the lifetime of these pressure vessels, but in some cases, it prevent ecological damage such as the golf Mexico caused by an oil leak.



Fig. 2. Pollution-black tide



Fig. 3. pipeline exploded

Because of the high cost of repairing pipelines including oil and because of the access and cost of labor and material difficulties, the industry has provided an alternative use of liners. The liners are used for the repair and installation of pipeline in different field starting from hydrocarbons to the drinking water pipe, their interest is to reduce the cost and repair time that was fatal in the accident in the Gulf of Mexico. The authors address these cases by studying the problems encountered in the use of liner repair such as the folds [7], rehabilitation [8], the problems of wrinkling and collapse liner [9], and also performance test [10].

To sum up, the importance of liner for protection of structures against corrosion, material used for liners, the problems facing the liners is unquestionable, in addition to their benefit of the strength of the structure.

Pressure vessel lining

For a long time, the liner has been used in Europe in the pressure vessels to protect the structures against corrosion and abrasive phenomena. The materials used for the liner can be natural or synthetic. Specialists in compliance with international norms and standards must formulate each liner. The liner should both protect the structure and simultaneously be resistant to chemicals transported in pressure vessels.

Several types of liners can be recognized in the industrial field that varies depending on the conditions of use. Moreover, according to CEN, there are different designations of the liner that are labeled as structural / semi-structural or Interactive / Independent.

Interactive liner

Requires using the host structure to resist to any internal pressure and can assist in preventing leaks.

Independent liner

May be a close fit or loose fit; for a loose fit, the liner can in any case withstand a long-term internal pressure without the help of the host structure. For the close fit, the liner transmits a part or the entire internal pressure in the base structure, and it is in no way quite resistant to this pressure.

The choice of the material of the liner is highly dependent on conditions of use, and it should take into account the chemical material transported or phenomena abrasions. There are some examples that are widely used in industry such as HDPE (High Density Polyethylene), the rubber and rubber-like, as well as polyurethane and others. It is indispensable also to mention the metal liners used in combination with composite tanks for the storage and transportation of hydrogen. Several standards and normalization predefine the rules of design and utilization and implementation liners are cited in ASTM [11] and ASME [12], in addition to the terms and conditions we

can calculate the minimum and maximum thickness of the liner.

Fatigue of pressure vessels.

We consider fatigue as the biggest cause of damage of the pressure vessels; consequently, design codes list several rules to follow when designing, manufacturing and using the pressure vessels.

The fatigue damage may be the result of a cyclic loading or thermal. It is recommended by many design codes to use the concept of the endurance limit in the design of pressure vessels. This concept is defined as the stress limit that applied to this structure so that it can support an infinite number of cycle; often the number of cycles is limited to 10^7 cycles.

Generally, there are two types of fatigue, high cycle fatigue and low cycle fatigue. The low cycle fatigue requires a lower cycle number and involves excessive deformation, and it is strongly related to plastic deformation in the material. The fatigue study in the case of low cycle fatigue is based on the number-strain curves cycle. For high cycle fatigue, it produces a large number of cycles, and damage may occur due to a lower loading than the elastic limit of the material. In fact, there are still plastic deformation at the microscopic scale. Based on this case, we use stress-cycle curves for the fatigue study. In general, fatigue damage is the result of many causes that are related to materials as inclusion or imperfections that are the zones of the initiation and propagation of crack by fatigue. Moreover, geometry is also concerned to be a major cause of fatigue as the case of its sudden change that causes stress concentration, which makes of fatigue damage inevitable.

The fatigue study of pressure vessels is based on the use of Tresca criteria, taking into account the maximum shear stress in addition to the rules of Miner's [13] to estimate the cumulative damage due to cyclic loading. For the stress concentrations, it is advisable to use the theoretical stress concentration factors [14] to analyze the effect of the geometry of the structure of behavior, as well as [15] for pressure vessels is strictly forbidden to approach the value of 5 for stress concentration factors, in some cases this value should not exceed 4.

Specific rules for pressure vessels, which undergo cyclic loads, are established by Langer [16]. Langer has established six rules that take into consideration the load fluctuations, temperature changes, and other parameters such as the type of material and the factors of stress concentrations. They do not exceed the value of 2 when the nominal stress equals 3SM (sm is called stress intensity as per ASME design, usually equal to 2/3 of the yield strength).

Lined pressure vessel model

Each pressure vessel must comply during its design the standard instructions. For this reason, it is planned to be

taken as an example to study a pressure vessel designed according to international standards and meets safety standards.

Our goal is to study the impact of a liner on the fatigue strength of a pressure vessel. For this reason, we chose to make numerical simulations and use all the techniques available to assess the parameters that influences our model. The aim is to numerically evaluate fatigue in the model in two particular cases; the first one is a standard pressure equipment, on which cyclic loading will be applied, simulating the conditions of use for the entire life of the product, and the second case is a pressure vessel with a liner, which subjected to the same conditions.

We have opted to study steel pressure vessel, and for the liner, we have chosen an interactive liner type (section), whose material that respects the operating conditions (i.e. the protection of corrosion) is elastomeric. We will focus on fatigue study of steel cylinder, fatigue liner itself is not considered. It is assumed in the study that the bonding between the two bodies is permanent and indestructible.

A parametric study has been conducted to find the best liner thickness taken as reference to the thickness of the shell, and then the thickness of the liner would be 50%, 75%, 100% or even 200% of the thickness of the shell.

Pressure vessel data

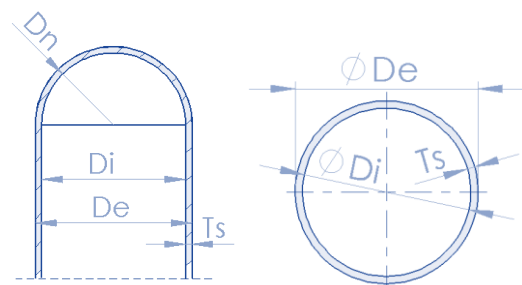

Fig. 4. Geometrical design of pressure vessel

Table 1 The pressure vessel data

Designation		Values
Di	internal diameter	388 mm
De	external diameter	408 mm
Dn	diameter head	388 mm
Ts	Thickness	10
Pmax	maximum pressure	7.5 MPa

Positioning of the liner

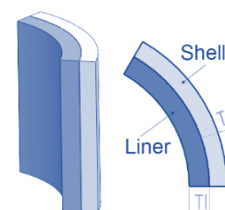

Fig. 5. positioning of the liner

Table 2 thickness data

Désignation		Valeurs
Ts	Epaisseur shell	10 mm
Tl	Epaisseur liner	--

Numerical simulation

We have chosen to make a numerical simulation for the fatigue study for normal pressure vessels and those equipped with a liner.

Material selection

We have selected several types of materials for the liner because its main goal is protecting the structure against the attacks of certain products. We have targeted the major categories of materials, each is resistant to a specific product. There are some materials that are resistant to petroleum products, other resist to strong acids, while others have good resistance to organic solvents.

Table 3 Table of liner materials and their resistance to chemicals

We tried to take a material of each category to examine the impact of the liner. The most efficient material allow you to search the optimum thickness, taking into account the economic impact as well the manufacturer that can choose the material and thickness that respects its set of specifications. The table () summarizes the main characteristics of liners studied in relation to aggressive media. It may be noted that some materials such as elastomer Perfluoro (FFKM) and Fluoro elastomer (FEPM) have a high resistance to all types of products; however, they are disadvantaged by their excessive price. The others materials have acceptable resistance especially for petroleum products, but varies between limited and acceptable use for other products. These elastomers are the result of careful pre-selection based on several criteria. The main criterion is the chemical durability followed by the mechanical behavior as the compressive strength, the yield strength, and the fatigue. Being limited by economic criteria, it is difficult to choose a material that could not become industrial use because of its price; however, we have, in some cases, to choose an expensive material that is the only appropriate material for certain chemicals such as strong acids.

The Fig.6 is a screening tool based on two criteria: the yield strength and fatigue resistance at 10^7 cycles. We can observe the relationship between these two criteria, the greater the yield over the fatigue strength increases. We come out with a yield criterion as a criterion of choice between the materials. Another relationship see Fig.6 is between the fatigue strength of compressive strength can also be used as a selected criterion for the choice of the material.

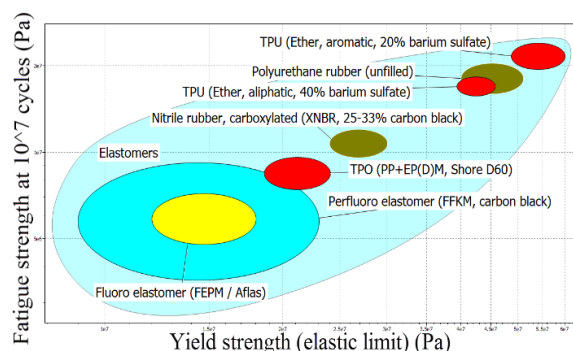

Fig. 6. Fatigue strength / yield strength of material's liner

Simulation data for Pressure Vessel Standard

Geometry

In the standard case, which presents a pressure vessel without liner, is shown in Fig.7 was chosen to take 1/8 of the cylinder because the model is symmetric.

Boundary conditions

We opted for cylindrical symmetry conditions, with the application of a uniformly distributed internal pressure Fig.7.

	Acids		Alcalins		Organic solvent	Oils and fuels
	W	S	W	S		
Nitrile-rubber, carboxylated (XNBR, 25-33% carbon black)	**	-	***	***	*	**
Perfluoro elastomer (FFKM, Carbon Black)	***	***	***	**	***	***
TPO(PP+EP(D)M, Shore D60)	***	**	***	***	*	*
Fluoro elastomer (FEPM/Aflas)	***	*	***	***	***	**
TPU (Ether, aromatic, 20% barium sulfate)	*	-	**	-	*	**
TPU (Ether, aliphatic, 40% barium sulfate)	*	-	**	-	*	**
Polyuréthane rubber	*	-	**	-	*	**

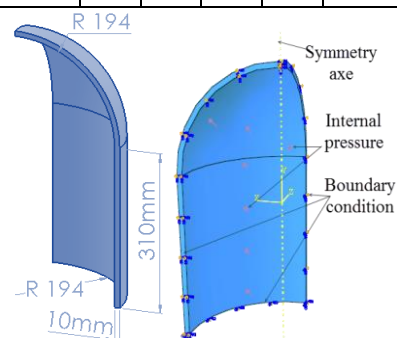

Fig. 7. Boundary conditions (Standard PV)

Simulation data for lined Pressure Vessel

Geometry

The shape of the liner perfectly fits the inner surface of the cylindrical shell Fig.8.

Boundary conditions

We also define the same cylindrical symmetry conditions. Therefore, we add the contact conditions between the two bodies in such a way as to meet the conditions established above, describing the liner and the cylinder stuck firmly, without any possibility of penetration.

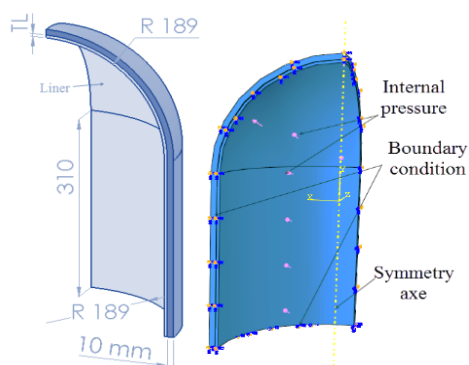

Fig. 8 Boundary condition (lined PV)

Material data

Cylinder

For the cylinder, a normalized steel was used, with the designation: ASTM-A715-G80-2. Based on an S-N approach, the experimental curves are shown on the Figure.9.

Table 4 PV-Steel data

Young's modulus (MPa)	206 800
Poisson ratio	0.33
Maximum stress (MPa)	664
Elastic limit 0.2%(MPa)	581
Fatigue strength (106 cycles) (MPa)	509

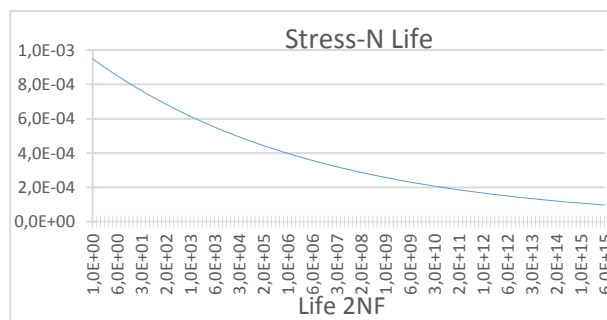

Fig. 9. Fatigue (S-N) Curve

Liner

Mechanical material data studied for the liner are presented in the table (5). Our objective is to select between good and bad values in relation to the dataset and differentiate the materials that will respond better to our objective in order to increase the lifetime of pressure vessels subject to cyclic loads.

Table 5 Liner's Materials data

	Young's modulus (MPa)	Poisson's ration	Elastic limit (MPa)	Fatigue strength (10 ⁷ cycles) (MPa)	density (Kg/m ³)	Price (Euro/Kg)
Nitrile-rubber, carboxylated (XNBR, 25-33% carbon black)	17	0.495	30	12	1180	5,19
Perfluoro elastomer (FFKM, Carbon Black)	24	0.499	23	9.2	2000	1 330
TPO(PP+EP(D)M, Shore D60)	795	0.435	24	9.61	917	2,63
Fluoro elastomer (FEPM/Aflas)	6.23	0.499	18	7.2	1600	55,2
TPU (Ether, aromatic, 20% barium sulfate)	207	0.488	59.9	24	1390	5,21
TPU (Ether, aliphatic, 40% barium sulfate)	1230	0.428	45.7	18.3	1550	8,57
Polyuréthane rubber	30	0.49	51	20.4	1210	4,86

Bad value

Best Value

Results

Liner's material study

Case N°1: static load

We have conducted a static study for several cases where the pressure vessel is devoid of liner and other case with a liner of each material. This study would be the basis for a lifetime analysis. A uniform pressure is applied (Fig.8) on the inner surface of the cylinder or liner.

The numerical study requires the consideration of non-linear effects of materials used for the liner as well as the effect of incompressibility. It impels us to use mixed finite elements in the case of a mechanical elasticity formulation. These type of finite elements have the power to increase the accuracy of the results of the stress field, especially for incompressible materials, when the Poisson's ratio tends to (0.5), which is the case for elastomers.

We have chosen to take into account the equivalent Von Mises stress and the TRESCA and displacement. The tables (6) and (7) shows the results of a cylinder with a

liner (thickness = 15 mm TL) (TPU <Ether, Aliphatic, 40% Barium sulfate>) and without liner. Other results are considered in details in the graphs (10) (11).

We notice a decrease of the stresses and the displacement between the standard case and the case of the pressure vessel with liner; in both cases, the stress fields and displacement are located on the cylindrical section, while on the head section these fields are lowest.

In the case of the pressure vessel with a liner, it is noted that the stresses in the liner are smaller than the cylinder while is the opposite for the displacement.

Table 6 Stress and Displacement results for Standard PV

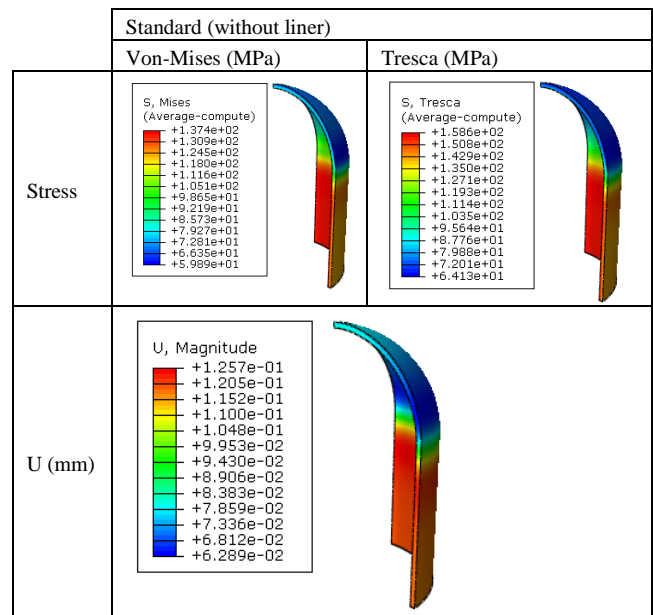

The results for the other material's liner are grouped in the graph (10) (11). for this thickness of the liner (15 mm) which is equal to 150% the thickness of the shell of the pressure vessel, it is noted the high performance of the TPUs and TPOs and a good performance of other materials with the exception of Nitrile rubber and Perfluoro FFKM, they have poor performance and requires optimization of the thickness.

The best materials are the two types of TPUs: aliphatic and aromatic, but also, the TPOs give a good result. we need to select one of these materials to make an optimization of the thickness.

Table 7 Stress and Displacement results for Lined PV

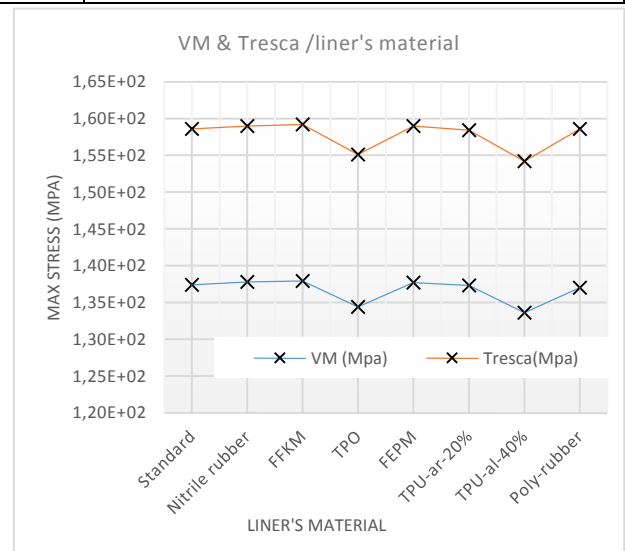
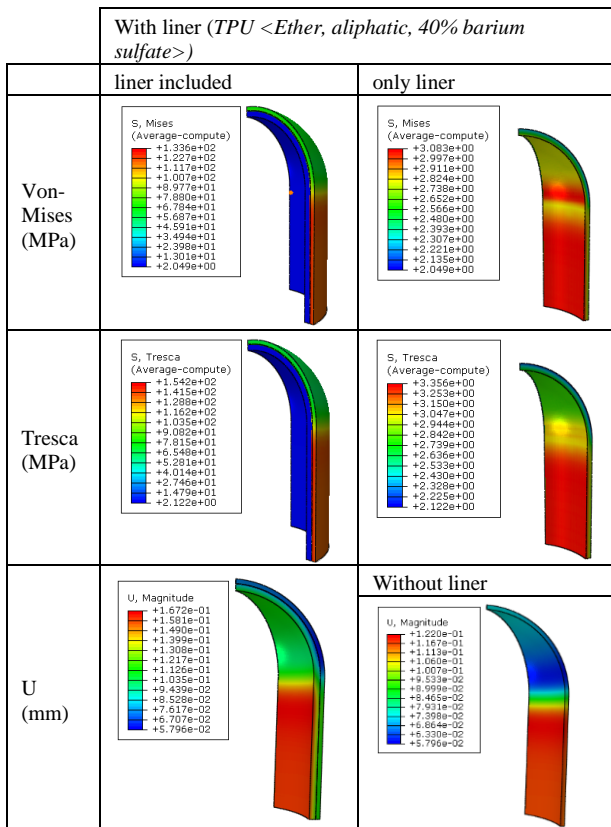

Fig. 10 VM and Tresca Stress / liner's material

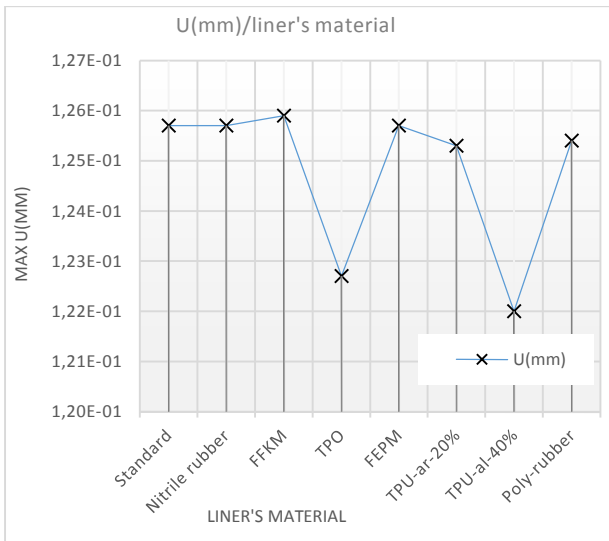

Fig. 11. displacement result for lined pressure vessel (15mm) / Materials

Case N°2 Cyclic Loading

Thanks to the results of the static study, one could simulate a study of the life of the structure under cyclic loading. We have chosen a load ratio $R = 0$. S-N algorithm used provided by [17]. The surface finish is in the order of $40\mu m$. We will look at two main results, the minimum number of cycle (Ncycle) and maximum damage (Dmax). Only be evaluated the life of the cylinder, that of the liner is not covered by this study.

We reiterate the same study with the same conditions for all materials of the liner, and we have compared the results to choose the best. Graphs (12) and (13) has respectively the minimum number of cycle in the cylinder and the maximum damage.

There are marked increases of minimum number of cycle (Ncycle) for TPUs and TPOs. For the case of a liner with a thickness equal to 150% the thickness of the cylinder. It also notes a good improvement of the damage for the same materials which lead us to advise these materials as a liner given their high performance for increased fatigue strength of the cylinder, while playing their main role is protection against attack by certain aggressive products.

If it is necessary to choose a single material, we will probably prefer to use TPU (Ether, aliphatic, 40% barium sulfate), given its level of efficiency. So if you compare it with the TPU (Ether, aromatic, 20% barium sulfate), we notice that it is inherently more efficient by comparing its fatigue strength that is greater than our aliphatic TPU (Table (5)).

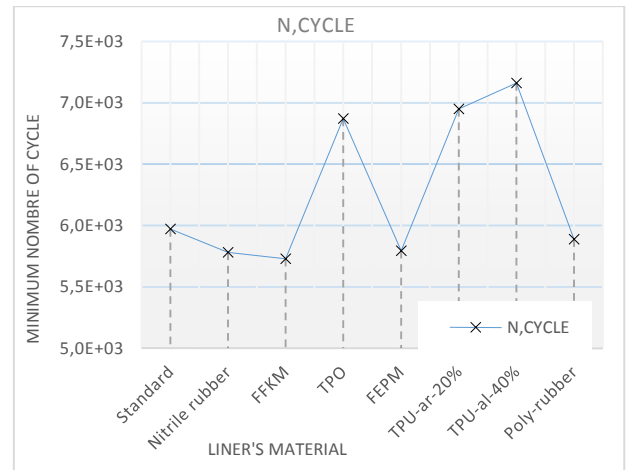

Fig. 12. Ncycle life /materials (liner 15mm)

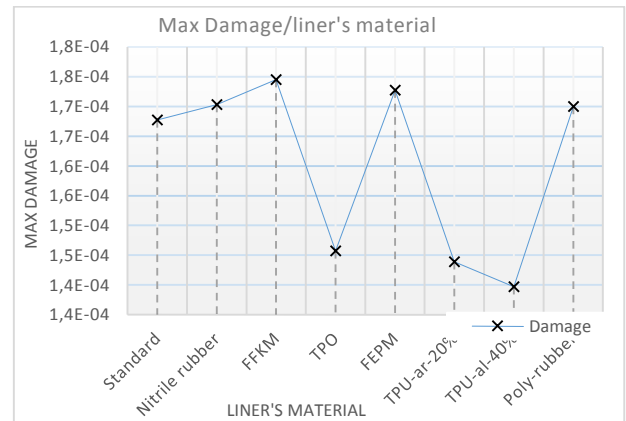

Fig. 13. Max Damage /materials (liner 15mm)

Study of liner's thickness

We Perform a parametric study of the thickness of the liner in order to find the best and the bad thickness. We have opted for using the TPU (Ether, aromatic, 20% barium sulfate) given its high resistance to fatigue as well as its low density by comparing it with the TPU (Ether, aliphatic, barium sulfate 40%) and its price.

For this study, we choose a thickness ranging from 50% to over 300% of the thickness of the cylinder. The aim is to find from what thickness improving the fatigue strength of the structure becomes significant. As long as we increase the thickness, volume and weight of the liner increase and, consequently, its price and installation costs increase. The procedure is as the same as in previous studies, we start with a static study with the same conditions.

Results

Case N°1: static load

The results of the static loading are given in the following table:

Table 8 Stress and displacement result / Thickness of liner

Thickness (mm)	Von Mises (MPa)	Tresca (MPa)	U (mm)
5	1,38E+02	1,59E+02	6,22E-02
10	1,37E+02	1,58E+02	1,25E-01
15	1,344E+02	1,551E+02	1,226E-01
20	1,34E+02	1,55E+02	1,23E-01
30	1,361E+02	1,571E+02	1,243E-01
35	1,36E+02	1,57E+02	1,24E-01

A significant improvement is noted for liner's thickness equal to 15 mm. The liner with the thickness 20 mm gave a better result.

Case N°2 Cyclic Loading

In the same manner as in the preceding paragraph. We perform a fatigue study, with the same conditions, results are obtained for each thickness (see graph (14) and (15))

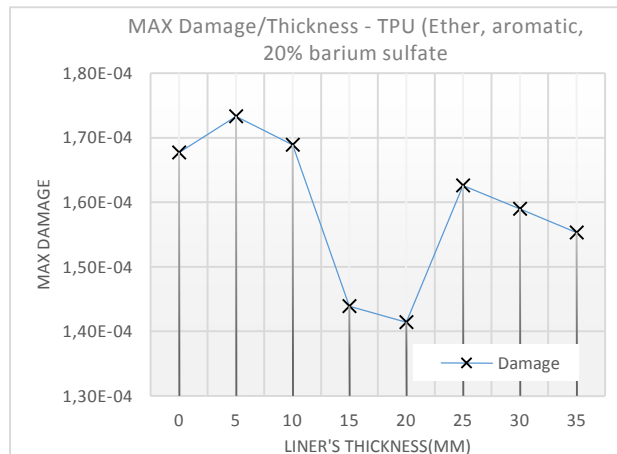

Fig. 14. Max Damage/ Thickness of liner

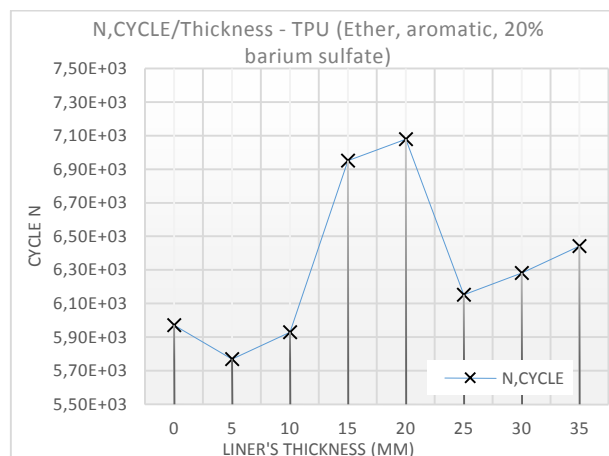

Fig. 15. Ncycle life/Thickness of liner

It is noted from these results that the best thickness for the liner is 20 mm as it gives very good results for the damages as well as the number of cycles.

Optimization rate for each liner are shown on the graph (16). Thus the liner material (TPU (Ether, aromatic, 20% barium sulfate)) and 20mm thick shows the best results, the optimization rate up to 19% for the number of cycles, and 16% for damage.

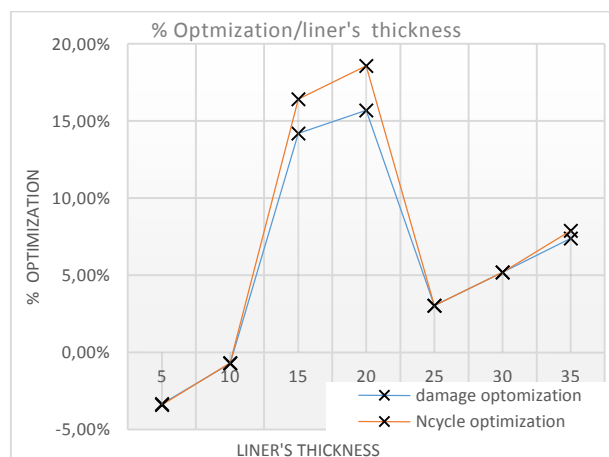

Fig. 16. Optimisation rate /Thickness of liner

The results obtained in this study has concluded that the use of a liner of thickness equals twice the thickness of a steel cylinder, 20 mm. The results show a real improvement in the lifetime of the pressure vessel, from which the actual impact of installing a liner inside an ASP. Otherwise, the other study [18] that has examined the impact of a liner on the mechanical behaviour of a cylinder of composite demonstrates the improvement of the mechanical behaviour of the cylinder, which is consistent with our results showing an improved resistance pressure vessel of fatigue.

Conclusion

The study of the impact of the liner on the fatigue strength of a pressure vessel has been performed. We deduce the importance of using the liner in order to increase the fatigue life of the structure. In addition to its impact on life thanks to its corrosion protection structure and its non-negligible role in the optimization of the fatigue strength, the liner becomes an indispensable tool for all pressure vessels. Its use on pressure vessel storing or transporting corrosive remains normal, what is advisable is using it in cases where it is not necessary to be used.

We have studied several types of materials for the liner through which we indicate the superiority of TPU and TPO that have a good performance. The thickness of the liner was also examined and we concluded that 20 mm is the best configuration. Additionally, we estimated 15mm as another configuration that provides good results.

References

- [1] A. Hocine, A. Ghouaoula, F. Kara Achira, and S.M. Medjdoub, Analysis of Failure Pressures of Composite Cylinders with a Polymer Liner of Type IV CNG Vessels, *International Journal of Mechanical, Industrial Science and Engineering* Vol:7 No:1, 2013
- [2] Federico Rueda, José Luis Otegui, Patricia Frontini, Numerical tool to model collapse of polymeric liners in pipelines, *Engineering Failure Analysis*, 20, 2012, pp. 25–34.
- [3] Y.T. Kim, B. Haghpanah, R. Ghosh, H. Ali, A .M.S. Hamouda, A . Vaziri, Instability of a cracked cylindrical shell reinforced by an elastic liner *Thin-Walled Structures*, 70, 2013 39 – 48,
- [4] Makar, J.M., Desnoyers, R., McDonald, S.E., Failure modes and mechanisms in gray cast iron pipes. In: Knight, Thomson (Eds.), *Underground Infrastructure Research: Municipal, Industrial and Environmental*. Swets & Zeitliner, Lisse, 2001, ISBN 90 2651 820 X.
- [5] Rajani, B., Zhan, C., Kuraoka, S., Pipe–soil interaction analysis for jointed water mains. *Canadian Geotechnical Journal* 33, 1996, pp. 393–404.
- [6] American Society for Testing and Materials (ASTM), Standard Specification for Cured-in-Place Pipe Lining System for Rehabilitation of Metallic Gas Pipe. 2002, ASTM F 2207-02, Philadelphia.
- [7] A. Jaganathan, E. Allouche, M. Baumert, Experimental and numerical evaluation of the impact of folds on the pressure rating of CIPP, liners *Tunnelling and Underground Space Technology*, 22, 2007, pp. 666–678.
- [8] Wei (Zach) Zhao, Raja Nassar, David Hall Design and reliability of pipeline rehabilitation liners, *Tunnelling and Underground Space Technology*, 20, 2005, pp. 203–212.
- [9] Lin Yuan, Stelios Kyriakides, Liner wrinkling and collapse of bi-material pipe under bending, *International Journal of Solids and Structures*, 51, 2014, pp. 599–611.
- [10] Michael J.P. Brown, Ian D. Moore, Amir Fam Performance of a cured-in-place pressure pipe liner passing through a pipe section without structural integrity, *Tunnelling and Underground Space Technology*, 42, 2014, pp. 87–95.
- [11] ASTM American society for testing and material
- [12] American Society of Mechanical Engineers, Boiler and Pressure Vessel Code, ASME, New York, 2013.
- [13] Miner, M.A. Cumulative damage in fatigue, *J. Appl. Mech.*, 12, 1945, pp. A159–A164.
- [14] W. D. Pilkey and D. F. Pilkey, *Peterson’s Stress Concentration Factors*, 3rd ed., John Wiley & Sons, New York, 2008.
- [15] W J O’Donnell, Code Design and Evaluation for Cyclic Loading—Sections III and VIII , DOI 10.1115/1.802191.ch39.
- [16] Langer, B.F., Design of pressure vessels for low cycle fatigue, *J. Basic Eng.*, 84(3), September 1962, pp. 389–402.
- [17] Dassault systems FE-Safe technology
- [18] E.S. Barboza Neto, M. Chludzinski, P.B. Roese, J.S.O. Fonseca, S.C. Amico, C.A . Ferreira, Experimental and numerical analysis of a LLDPE/HD PE liner for a composite pressure vessel, *Polymer Testing*, 30, 2011, pp. 693– 700.