

# Multi-information Fusion and Filter Study of Multi-sensor Velocity Measurement on High-speed Train

HOU TAO, NIU HONGXIA  
Lanzhou Jiaotong University  
602 Postbox No.88 Anning West Road Lanzhou, China, 730070  
CHINA  
houtaoh@mail.lzjtu.cn

*Abstract:*-For the rapid development high-speed railway system, improvement approach of the velocity measurement accuracy has been studied based on multiple speed sensors on high-speed train. In this method, the velocity measurement data from multi-channel speed sensors were dealt through data fusion of arithmetic mean filter, weighted arithmetic mean filter, Federated Kalman filter and adaptive Federated Kalman filter algorithm. On this basis, the comparative study was carried out both at high speed and at low speed based on weighted average algorithm, and algorithm of Federated Kalman filter and adaptive Federated Kalman filter were designed. Discussing the adaptive Federated Kalman filtering problem that four channel sensors are normal and one of sensors is faulted. Then simulation parameters and coefficients were set according to the algorithm and simulated in MATLAB. The results show that it can achieve better fusion effect base on Federated Kalman filter and adaptive Federated Kalman filter algorithm. And the adaptive Federated Kalman filter algorithm is applied to high-speed train system, which has improved the velocity measurement accuracy and fault tolerance, and made the high-speed railway system has better adaptability and improve the train's operating efficiency based on controlling trains safely running.

*Key-Words:*-rail transportation; high-speed train; velocity measurement accuracy; information fusion; Kalman filter

## 1 Introductions

The running speed of the high-speed trains has been increasing with the rapid development of the high-speed railway. It is difficult for single-channel speed sensor to meet the requirements for reliability and security of the velocity measurement under the condition of high-speed train running[1]. Through Comparing the single-channel speed sensor technology with multi-channel speed sensor fusion technology, multi-channel speed sensor fusion can get more reliable and more accurate information[2-6]. High-speed train used a combination of the wheel speed sensor and the Doppler radar to measure the train speed in China. The wheel speed sensor has the advantage of interfering from the external environment and weather, etc, and the speed measurement is more accurate at high speed. The velocity measurements of the speed radar is more accurate when the wheel is slipping or skidding and it is at low speed[2-5]. More precise train speed can be achieve to receive the complementary advantage when both devices are used. The measurement accuracy decreases that is likely to cause cumulative errors, endanger traffic safety since the sensor is inevitably subject to external interference and internal noise(such as traction changes, wheel spin,

abrasion, external climatic conditions, the sensor measurement error of itself and the pulse acquisition error and other factors) during the measurement process and the information transmission process. Therefore, the speed information fusion processing unit will need to make integration and error correction to eliminate noise and get an accurate train speed[4]. In order to meet speed control requirements of high-speed train, reflect the superiority of the improved method, a variety of fusion and filtering methods for the multi-channel speed sensor were researched and compared in this paper.

## 2 The arithmetic mean filter study on the multiple speed information

At present, there are two equipments on a high-speed train in China. Each device is equipped with a vehicle wheel speed sensor and a radar speed sensor which is shared by the two vehicle equipment. In order to improve velocity measurement accuracy, used the mean velocity value of four channels information as a real-time speed. But it must consider the problem that if the velocity value of

one of sensors has a large change or is far away compared with the other three sensors, it is determined that the sensor has fault, so its speed value must be abandoned, and then the mean velocity value of three channels information as a real-time speed.

In order to verify this method is feasible, supposed that the expected speed is 300km/h and it's accelerated speed is zero, and the reading period is 1.0s in the specify simulation. The definitions of four channels speed sensor are radar speed sensor 1, wheel Hall speed sensor 2, radar speed sensor 3 and wheel Hall speed sensor 4. According to the method and parameters, the program was programmed in MATLAB, and the simulation speed values of 4 channels speed sensor were gotten by random function in MATLAB. The simulation results of the arithmetic mean filtering process which is shown in Fig.1 is obtained through debugging and running.

In order to make the simulation is more close to actual operation process, supposed that the train run uniform velocity at  $v=300\text{km/h}$  until 40 read period, and then accelerated run at  $\dot{v} = 0.3\text{m/s}^2$  until 30 data read period and deceleration run at  $\dot{v} = -0.2\text{m/s}^2$  until 30 data read period. The simulation result is shown in Fig. 2.

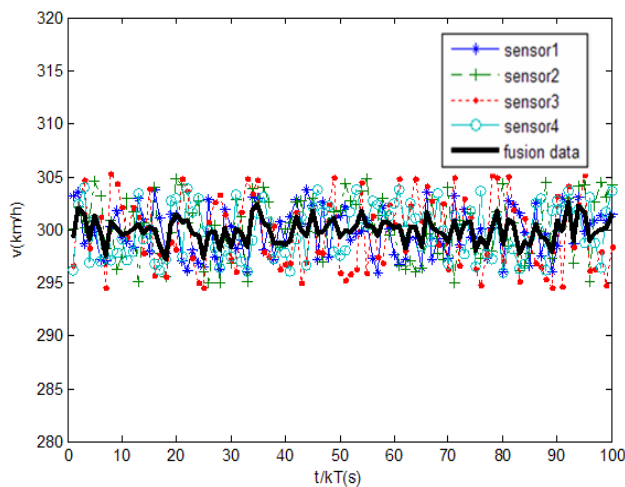

Fig.1 Fusion result profile of arithmetic mean filter base on 4 channel speed informations

From Fig.1 and Fig.2, it can be seen that the speed value of the arithmetic mean value fusion and filtering processing which has smaller fluctuations than the speed value of the single channel speed sensor is more stable, and it can be close to the true value of the real-time train's speed. This method is simple and applicable to meet the control requirement of some of trains.

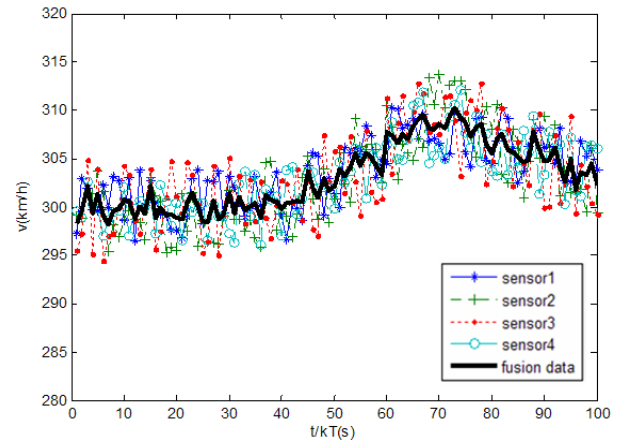

Fig.2 Fusion result of arithmetic mean filter in acceleration and deceleration

### 3 Research on the Weighted Aarithmic Mean Filter

During the actual running of high-speed trains, in the case of accuracy need is not very high, the arithmetic mean filter which achieves certain results can meet the basic requirements. However, there are some deficiencies. For instance, the error of radar sensor is large at high speed, some bigger errors may emerge for the wheel speed sensor at low speed[2-5]. So the weighted arithmetic mean filtering is used, that is to say that the proportion of the wheel speed sensor values is increased at high speed and the proportion of radar speed sensor value is increased at low speed. Defining  $v$  as the real-time speed value,  $v_T$  as the setting speed threshold value between the high-speed and low-speed,  $c_1$  and  $c_2$  as the weighting factor, and they can meet  $c_1 + c_2 = 1$ . When  $v > v_T$ , the proportion of the wheel speed sensor value should be increased, then  $c_1=0.1$  and  $c_2=0.4$  that were found through a lot of simulation experiment are selected to simulate, when  $v \leq v_T$ , the proportion of radar speed sensor value should be increased, then  $c_1 = 0.4$  and  $c_2 = 0.1$  are selected. This method of determining sensor fault has the same way as before. Setting  $v=300\text{km/h}$   $v=25\text{km/h}$  as speed of control system,  $v_T=30\text{km/h}$ , accelerated and deceleration are set as before. According to the set speed value and weighting coefficients, the program is programmed in MATLAB, the simulation results through debugging and running is obtained as shown in Fig.3 and in Fig.4. Fig.3 is a simulation result at high speed, Fig.4 is a simulation result at low speed.

From the results in Fig.3 and Fig.4, it can be seen that the speed amplitude variation of the single channel radar speed sensor is larger, and the stability

is poor at high speed. While the speed amplitude variation of the single channel wheel speed sensor is larger, and the stability is poor at low speed. But also it can be found that the weighted arithmetic mean filter can achieve better results whether at high speed or at low speed. Compared Fig.3 and Fig.4 with Fig.1 and Fig.2, the smoothness is better in Fig.3 and Fig.4.

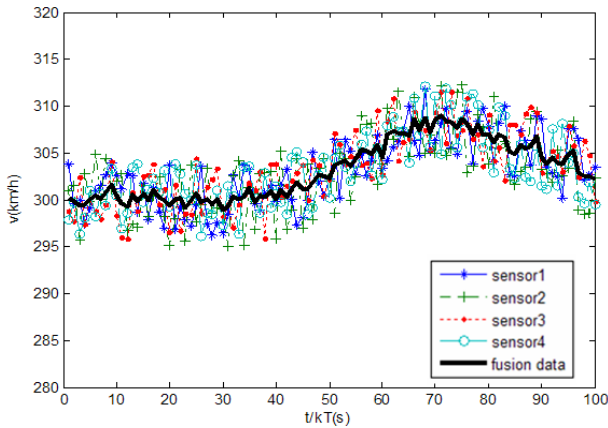

Fig.3 Fusion result of weighting arithmetic mean filter at high speed

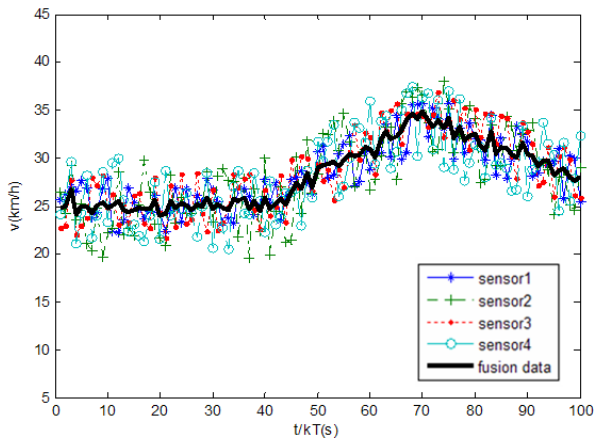

Fig.4 Fusion result of weighting arithmetic mean filter at low speed

#### 4 Study of multi-channel speed information fusion based on Federated Kalman filtering

The multi-sensor information fusion technology based on Federated Kalman filter is that making several speed sensor measurement information as input, using the idea of distributing processing at first, and then making recursive algorithm, global fusion through updating time and updating observation, and making the global optimal estimate value after fusion as the system output[4]. This method has characteristics of flexible design, small computation, good fault tolerance and so on. Not

only it can improve the fusion precision, but also it is still able to guarantee the accuracy of the output signal in a channel sensor fault state, and it is the preferred solution to solve the problem that velocity measurement accuracy is poor.

#### 4.1 Discrete system model

Because the output signals of the wheel speed sensor and radar sensor are discrete high frequency pulse signal, the velocity measurement is a discrete system. According to the discrete system characteristics, the discrete mathematical model of the train velocity measurement system is as follows[1,4-9]:

$$X(k+1) = \Phi(k+1, k)X(k) + BU(k) + W(k) \quad (1)$$

$$Z(k) = H(k)X(k) + V(k)$$

and

$$X(k) = [v(k), \dot{v}(k)], \Phi(k+1, k) = \begin{bmatrix} 1 & T \\ 0 & 0 \end{bmatrix}$$

$$U(k) = [0 \quad u(k)]^T, W(k) = [0 \quad w(k)]^T$$

Where  $k$  is a sample sequence of sensors,  $X(k)$  is the state vector at the moment,  $\Phi(k+1, k)$  is the state transition matrix,  $B$  is input control matrix,  $U(k)$  is input vector of the system,  $W(k)$  is the random noise vector,  $Z(k)$  is the observation vector,  $H(k)$  is measurement matrix,  $V(k)$  is the observation noise vector,  $v(k)$  is the train speed,  $\dot{v}(k)$  is the train accelerated speed,  $T$  is a sample period,  $u(k)$  is the accelerated speed of input force,  $w(k)$  is the accelerated speed of input disturbance force[1,4-10]. The statistical properties are as follows:

$$\begin{cases} E[W(k)] = 0, E[W(k)W^T(j)] = Q(k)\delta_{kj} \\ E[V(k)] = 0, E[V(k)V^T(j)] = R(k)\delta_{kj} \\ E[W(k)V^T(j)] = 0 \end{cases} \quad (2)$$

Where  $Q(k)$  is non-negative definite covariance matrix of the random noise  $W(k)$ ,  $R(k)$  is positive definite covariance matrix of the observation noise  $V(k)$ ,  $\delta_{kj}$  is Kronecker function and it is defined as  $\delta_{kj} = 1(k=j)$  or  $\delta_{kj} = 0(k \neq j)$ .

Train speed information fusion system consists of a main filter and four sub-filter that are corresponding to the four speed sensor based on Federated Kalman filter algorithm. sub-filters are independent and parallel work. Four channel speed sensors provide the original speed measurement data to the speed measurement fusion processing unit. Each sub-filter make local filtering for the measurement data of sensor, and it send the result of local state estimation and the estimation error to the main filter, and then the main filter processes the

local filtering results, get the global optimal estimate data. In this process, according to the information distribution principle, the main filter makes the initial state information, public reference information and dynamic noise measurement information as a priori information which are assigned to each sub-filter, to obtain the local optimal fusion estimates[4-9].It is shown in Fig.5, the subscripts  $m$  and  $g$  represent the main filter and the result of the overall fusion.

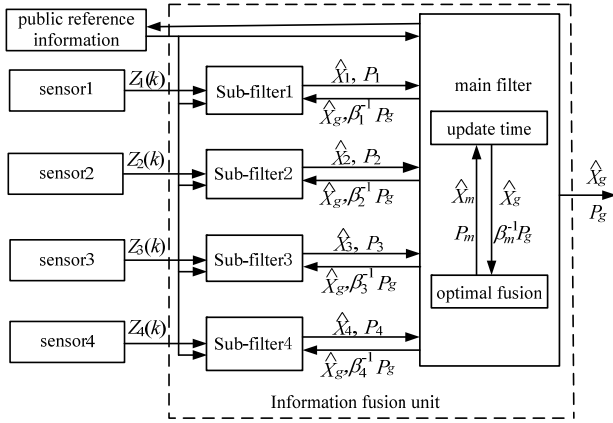

Fig.5 The fusion schematic diagram on Federated Kalman filtering

According to the principle of Federated Kalman filtering algorithm, set  $\hat{X}(k+1)$  as optimal state estimation at  $k+1$ , thus state equation and observation equation of one of 4 sub-filter are as follows:

$$\begin{aligned} X_i(k+1) &= \Phi(k+1, k)X_i(k) + W_i(k) \\ Z_i(k) &= H_i(k)X_i(k) + V_i(k) \end{aligned} \quad (3)$$

Original state condition of filter is as follows:

$$\begin{aligned} E[X(0)] &= \hat{X}, E[W_j V_k^T] = 0 \\ E[(X(0) - \hat{X})(X(0) - \hat{X})^T] &= P_0 \end{aligned} \quad (4)$$

### 4.2 Information Distribution Method of Federated Kalman Filtering

From Fig.5, it can be seen that the global fusion estimates data  $\hat{X}_g$  and its estimation error covariance matrix  $P_g$  are amplified to  $\beta_i^{-1}P_g (\beta_i \leq 1)$  and then be fed to the sub-filter, in order to reset the estimate data of sub-filter. Meanwhile, the estimation error covariance matrix of the main filter is reset to  $\beta_m^{-1}$  times of the global estimation error covariance matrix, that is  $\beta_m^{-1}P_g (\beta_m \leq 1)$ .  $\beta_i (i=1,2,3,4)$  is information distribution coefficient[3,7-11],  $0 \leq \beta_i \leq 1$  and  $\beta_1 + \beta_2 + \beta_3 + \beta_4 = 1$ .

It is a key problem for studying and designing of information distribution in Kalman filter[11]. There are several commonly methods for information distribution, such as zero reset type, nonzero reset type, no reset type, intelligent method and so on[11-14]. According to the information distribution knowledge and velocity measurement characteristic of sensor on high-speed train, designed a information distribution method of weighted nonzero reset type, that is  $\beta_m=0, \beta_1=\beta_3=0.1, \beta_2=\beta_4=0.4$  at high speed and  $\beta_m=0, \beta_1=\beta_3=0.4, \beta_2=\beta_4=0.1$  at low speed.

### 4.3 Federation Kalman filtering algorithm

Supposed that the initial value of the global state is  $X_0$  at starting time, its covariance matrix is  $P_0$ , the system covariance matrix is  $Q_0$ . Set,  $\hat{X}_i$  is the state estimates vector of the sub-filter,  $Q_i$  is the system covariance matrix,  $P_i$  is the state vector covariance matrix,  $\hat{X}_m$  is the state estimates vector of the main filter,  $Q_m$  is the system covariance matrix of the main filter,  $P_m$  is the state vector covariance matrix of the main filter.  $i=1,2,3,4$ .

The formula 3 shows that the process noise is weaker, the system state equation is more accurate, the information amount of the state equation is inversely proportional with the covariance of the process noise. Therefore, the information amount of the state equation can be expressed as the inverse matrix of the process noise covariance matrix  $Q^{-1}$ , the information amount of the state initial value can be expressed as the inverse matrix of initial estimate covariance matrix  $P_0^{-1}$ . The information amount of observation equation can be described as the inverse matrix of observation noise variance matrix  $R^{-1}$ . Meanwhile, the information amount of the state estimate can be represented by  $P^{-1}$ . The process of Federated Kalman filter algorithm is as follows [4-9,11-16]:

Information distribution process:

$$Q^{-1}(k) = \beta_i Q_g^{-1}(k), P_i^{-1}(k) = \beta_i Q_g^{-1}(k) \quad (5)$$

$$\hat{X}_i(k) = \hat{X}_g(k)$$

Recursion time update algorithm:

$$\hat{X}_i(k+1, k) = \Phi(k+1, k)\hat{X}_i(k) \quad (6)$$

$$P_i(k+1, k) = \Phi(k+1, k)P_i(k)\Phi^T(k+1, k) + Q_i(k) \quad (7)$$

Recursion measurement update algorithm:

$$\begin{aligned} P_i^{-1}(k+1) &= P_i^{-1}(k+1, k) + \\ &H_i^T(k+1)R_i^{-1}(k+1)H_i(k+1) \end{aligned} \quad (8)$$

$$\begin{aligned}
 P_i^{-1}(k+1)\hat{X}_i(k+1) = & \\
 P_i^{-1}(k+1,k)\hat{X}_i(k+1,k) + & \quad (9) \\
 H_i^T(k+1)R_i^{-1}(k+1)Z_i(k+1) &
 \end{aligned}$$

The global optimal estimation of information fusion:

$$\hat{X}_g = P_g \sum_{i=1}^{n,m} P_i^{-1} \hat{X}_i, \quad P_g = \left( \sum_{i=1}^{n,m} P_i^{-1} \right)^{-1} \quad (10)$$

#### 4.4 Simulation authentication

According to the Federated Kalman filter algorithm designed previously, the set point speed is set as  $v=300\text{km/h}$ , the information distribution coefficient is  $\beta_m=0, \beta_1=\beta_3=0.1, \beta_2=\beta_4=0.4$  and the information distribution at low speed is  $\beta_m=0, \beta_1=\beta_3=0.4, \beta_2=\beta_4=0.1$ . The other parameters are consistent with the previous text, the Federated Kalman filter algorithm procedures is programmed in MATLAB, the simulation results which is obtained through testing and running is shown in Fig.6 and Fig.7.

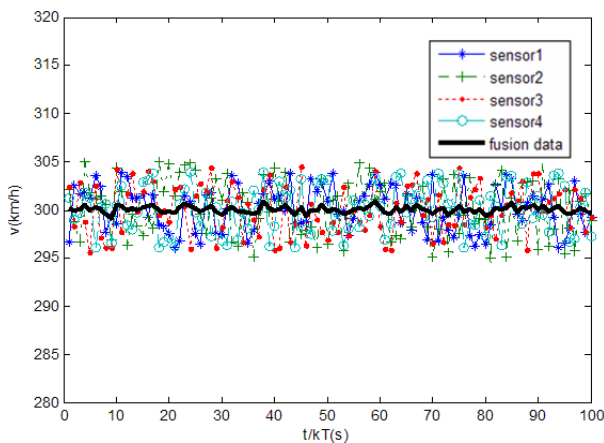

Fig.6 Fusion result profile of Federated Kalman filter at high speed

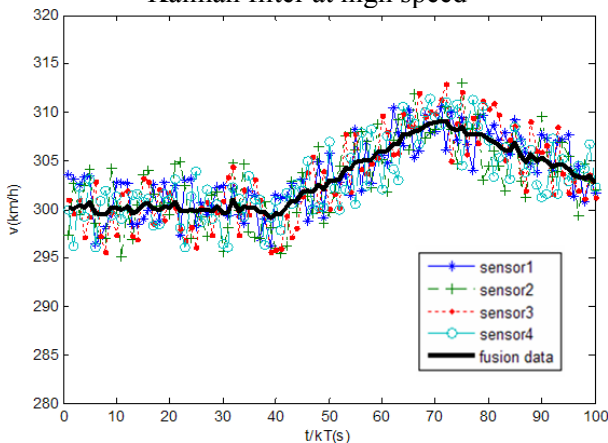

Fig.7 Fusion result profile of Federated Kalman filter at low speed

From Fig.6 and Fig.7, it can be seen that the Federated Kalman filter algorithm simulation results have been significantly improved compared to the average filter and the weighted average filter. The fluctuations of the fusion data amplitude is small, the smoothness is improved further. The Federated Kalman filter algorithm which use the characteristics of neutralizing the noise or the error between the sensors. Theoretically, the result is closer to the true value of the train speed. But it requires that the system has an accurate mathematical model and the exact noise statistical properties[4,5,17]. However, But in the process of the actual train operation, the system process noise covariance matrix  $Q$  and the measurement noise covariance matrix  $R$  can not be known in advance, so filtering may cause filtering diverging and declining system fusion accuracy[4,5,17]. At the same time, because the system error and measurement error can change with time and environment, that is to say the system process noise covariance matrix  $Q$  and the measurement noise covariance matrix  $R$  will change, Federated Kalman filter system may cause filtering results to diverge, filtering accuracy to decline due to lack of priori knowledge of system noise and measurement noise. It is not permitted for the speed measurement system of high-speed train which requires much higher in terms of safety and reliability. In order to better achieve that the noise signal is filtered, it is necessary to design the adaptive Federated Kalman filter algorithm to improve Federated Kalman filter algorithm to increase its adaptive capacity.

### 5 Study of multi-channel speed information fusion on adaptive Federated Kalman filtering

On the basis of references[1,4,5], Federated Kalman filter algorithm has shortage in case of changes in the statistical characteristics of the noise. adaptive Federated Kalman filter algorithm is designed to improve the measurement precision, to make the system has more high adaptive capacity, to optimize the information distribution coefficient on characteristic of sensor. And make comparative study in case of sensor fault or not.

#### 5.1 Adaptive Kalman filtering algorithm

The basic idea of the improved Federated Kalman filter algorithm is that the system noise estimation is added in the main filter and the noise estimation is add in every sub-filter sensor. Set  $s(k)$  as main filter's covariance of error and  $r(k)$  as sub-filter's

covariance of error. In order to reduce model error, suppress filter divergence and improve the precision of the filtering, the statistical properties of the system process noise and measurement noise are estimated and corrected in real-time. The basic process of algorithm is as follows:

Information distribution:

$$P_i^{-1}(k) = \beta_i P^{-1}(k), Q_i^{-1}(k) = \beta_i Q^{-1}(k) \quad (11)$$

$$\sum \beta_i + \beta_m = 1, \hat{X}_i(k) = \hat{X}(k) \quad (12)$$

$$i = 1, 2, 3, 4$$

Recursion time update:

$$P(k+1, k) = \Phi(k+1, k)P(k)\Phi^T(k+1, k) + Q(k) \quad (13)$$

$$\hat{X}(k+1, k) = \Phi(k+1, k)\hat{X}(k) + s(k) \quad (14)$$

$$P_i(k+1, k) = \Phi(k+1, k)P_i(k)\Phi^T(k+1, k) + Q_i(k) \quad (15)$$

$$\hat{X}_i(k+1, k) = \hat{X}(k+1, k) \quad (16)$$

$$\tilde{Z}_i(k+1) = H_i \hat{X}(k+1, k) - Z_i(k+1) \quad (17)$$

$$r(k+1) = \frac{k}{k+1}r(k) + \frac{1}{k+1}\tilde{Z}_i(k+1)$$

$$\hat{R}(k+1) = \frac{k}{k+1}\hat{R}(k) + \frac{1}{k+1} \cdot [\tilde{Z}_i(k+1) - r(k+1)] \cdot [\tilde{Z}_i(k+1) - r(k+1)]^T \quad (18)$$

Sub-filters measurement update:

$$P_i^{-1}(k+1) = P_i^{-1}(k+1, k) + H_i^T R_i^{-1}(k) H_i \quad (19)$$

$$P_m^{-1}(k+1) = P_m^{-1}(k+1, k) \quad (20)$$

$$\hat{X}_i(k+1) = P_i(k+1)P_i(k+1, k)\hat{X}_i(k+1, k) + P_i(k+1)H_i^T(k)R_i^{-1}(k)[Z_i(k) - R(k)] \quad (21)$$

$$i = 1, 2, 3, 4$$

$$X_m^{-1}(k+1) = X_m^{-1}(k+1, k) \quad (22)$$

The fusion of velocity measurement information:

$$P^{-1}(k+1) = P_m^{-1}(k+1) + \sum_{i=1}^N P_i^{-1}(k+1) \quad (23)$$

$$\hat{X}(k+1) = P(k+1)P_m^{-1}(k+1)\hat{X}_m(k+1) + \sum_{i=1}^N P(k+1)P_i^{-1}(k+1)\hat{X}_i(k+1) \quad (24)$$

$$\tilde{X}(k+1, k) = \hat{X}(k+1) - \hat{X}(k+1, k)$$

$$s(k+1) = \frac{k}{k+1}s(k) + \frac{1}{k+1}\tilde{X}(k+1, k) \quad (25)$$

$$\hat{Q}(k+1) = \frac{k}{k+1}\hat{Q}(k) + \frac{1}{k+1} \cdot [\tilde{X}(k+1, k) - s(k+1)][\tilde{X}(k+1, k) - s(k+1)]^T$$

## 5.2 Simulation verification

According to the adaptive Federated Kalman filter algorithm, the desired speed is set as  $v=300\text{km/h}$ , the information distribution and other parameters are consistent with the previous text, the Federated Kalman filter algorithm procedures is programmed in MATLAB, the simulation results are shown in Fig.8 and Fig.9.(The simulation result is similar to in Fig.7 at low speed)

The simulation results of the adaptive Federated Kalman filter algorithm is shown in Fig.8 when the sensors are not fault. The simulation results of the adaptive Federated Kalman filter algorithm is shown in Fig.9 when one of channel sensors has failure. It can be seen from Fig.8 and Fig.9 that the train speed profile fluctuate severely when the four channels speed sensor measure separately, and the velocity profile fluctuate significantly smaller after it is handled by the adaptive Federated filter, and compared Fig.8 with Fig.6, the improved filtering result has higher stability and higher precision than before improvement. Although one sensor is fault in Fig.9, it still has better fusion effect. It can be seen that the adaptive Federated filter has stronger fault-tolerant ability.

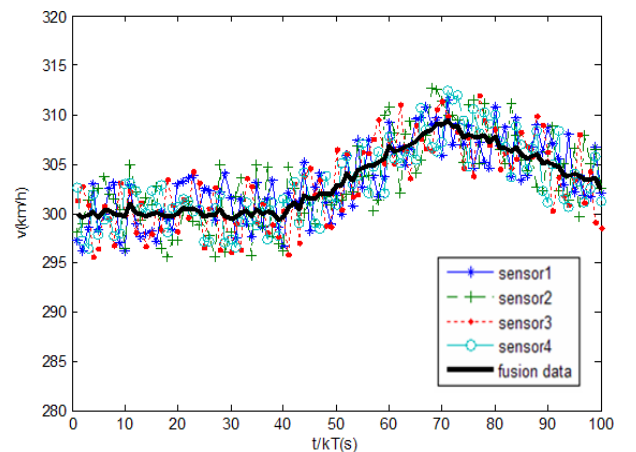

Fig.8 The fusion result profile of adaptive Kalman filtering

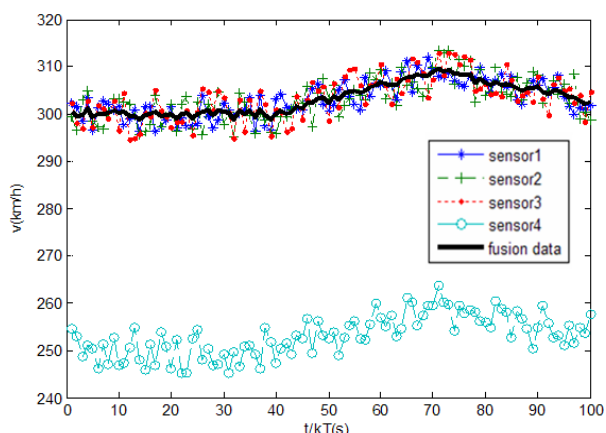

Fig.9 The fusion result profile of adaptive Kalman filtering in sensor fault

### 6 Errors contrastive analysis of four fusion and filter methods

In order to contrast fusion results, the errors of four fusion and filter methods have been statistic analysis. as follow Table 1.

Table 1 Errors contrastive analysis

fusion and filter method	actual speed error	Setting speed	average error before fusion	average error after fusion
arithmetic mean filter	±(4~6) km/h	300 km/h	1.67%	1.18%
weighted arithmetic mean filter	±(4~6) km/h	300 km/h	1.67%	0.83%
Federated Kalman filter	±(4~6) km/h	300 km/h	1.67%	0.50%
adaptive Kalman filter	±(4~6) km/h	300 km/h	1.67%	0.40%

From Table 1, multi-speed information fusion can make the average error rate of high-speed trains from about 2.0% decreases to 0.4%.

### 7 Conclusions

For the measurement precision problem of four channels speed sensor on high-speed train, several digital filtering method and data fusion method are analyzed and researched comparatively, that is the comparative study both high-speed and low-speed are carried out under the same method, and the comparative study both the four channels sensor are normal and one of them is faulted. From the study results it can be seen that the Federated Kalman

filter and adaptive Federated Kalman filter algorithm can get better effects, and the adaptive Kalman filter algorithm still can get better fusion results when a channel sensor has failure. Thus it can be seen that this method improves the velocity measurement accuracy and the system fault tolerance, so that it makes the high-speed railway system has better adaptability, which meet the requirements that on-board equipment can control the train safely at high speed. However, this result is the simulation result which has a gap with the actual train control. So the next step work of this paper is to build a test experiment platform to further verify the feasibility of the theory.

### Acknowledgments

The acknowledgement for Project Supported by National Natural Science Foundation of China (Grant No.61165006); Natural Science Foundation of Gansu Province(Grant No.1308RJZA116), Universities Scientific Research Project of Gansu province(Grant No.2013A-051) and Science and Technology Support Program of Lanzhou Jiaotong University(Grant No.ZC2013004)

### References:

- [1] Huang W Z, Ji X S, Liu L, et al. Several Crucial Techniques for the High Speed Adaptability of CTCS-3 Train Control Onboard Equipment. *Journal of the China railway society*, Vol.31, No.3, 2010, pp.87-91.
- [2] Wang J F and Wang X S. Research on Data Fusion of CTCS-3 Train Control System. *Journal of the China railway society*, Vol.34, No.9, 2012. pp70-74.
- [3] Lin Z, Wang J F, Wang Y L. Based on CPN to verify data fusion method of high speed railway TSR. *JOURNAL OF BEIJING JIAOTONG UNIVERSITY*, Vol.36, No.3, 2012, pp.41-46.
- [4] Yan J P, Chen X Q and Hou T. The study of train speed measurement information fusion based on the improved Federated Kalman filter algorithm. *Journal of railway science and engineering*, Vol.9, No.2, 2012, pp.89-93.
- [5] Yan J P. Study on Detection and Fusion of High-speed Train Running Information. Lanzhou: Lanzhou Jiaotong University, 2013
- [6] Zhang W F, Hu Z T, Cheng J X. A Multisensor Data Fusion Estimation Algorithm for Vehicle Maneuvering Target Tracking. *Journal of Guangdong University of Technology*, Vol.26, No.1, 2009, pp.36-39.

- [7] Cui P Y and Huang X R. Multi-sensor information fusion algorithm based on federal Kalman filter and its application. *ELECTRIC MACHINES AND CONTROL*, Vol.5, No.3, 2001, pp.204-207.
- [8] Luo R E ,Yi H C and Su K L. Multi-sensor Fusion and Integration: Approaches, Applications and Future Research Directions. *IEEE Sensors Journal*, Vol.2, No.2, 2002, pp. 107-119.
- [9] Sheng S Y and Wang J H. Application of Federated Kalman Filter in Multi-sensor Information Fusion. *Radar & ECM*, Vol.2002, No.1, 2002, pp.27-33.
- [10] Liu R H and Liu J Y. A New Method of Information Sharing in Federated Filter. *Journal of Chinese Inertial Technology*, Vol.9, No.2, 2001, pp.29-30.
- [11] Manu M Z and Mohammad J. *Time-delay Systems nalysis, Optimization and Application*. New York: AT&T Bell Laboratories. 1987
- [12] Fu H F ,Liu H W and Zhang Z L. Methods of public information sharing in Federated filter. *Fire Control and Command Control*, Vol.31, No.8, 2006, pp.56-58
- [13] Gu Q T and Wang S. Optimized Federated filter. *J Tsinghua Univ(Sci &Tech)*, Vol.43, No.11, 2003, pp.1460-1463
- [14] Yuan N, Yuan K F, Zhang H W. Discussion of information sharing principle for Federated filter. *NAVIGATION OF CHINA*, Vol.35, No.3, 2012, pp.11-15.
- [15] Yang W H. *Multi-velocity sensor data fusion and its application*. Xi'an: PUBLISHING HOUSES OF XIDIAN UNIVERSITY. 2004
- [16] Chen Y K ,Si X C and Li Z G. Federal Kalman Filter and Its Application to Multisensor Information Fusion Technology. *Journal of Projectiles, Rockets, Missiles and Guidance*, Vol.5, No.4, 2005, pp.946-952.
- [17] Xiao Y L and Zeng C. The study of Federated filter based on the adaptive Kalman filter algorithm. *Fire Control and Command Control*, Vol.33, No.12, 2008, pp. 88-94.