

3D Image Representation through Hierarchical Tensor Decomposition, Based on SVD with Elementary Tensor of size $2 \times 2 \times 2$

ROUMEN KOUNTCHEV

Radio Communications and Video Technologies

Technical University of Sofia

Bul. Kl. Ohridsky 8, Sofia 1000

BULGARIA

rkountch@tu-sofia.bg; <http://www.tu-sofia.bg>

ROUMIANA KOUNTCHEVA

TK Engineering

Drujba 2, Bl. 404/2

BULGARIA

kountcheva_r@yahoo.com

Abstract: - As it is known, groups of correlated 2D images of various kind could be represented as 3D images, which are mathematically described as 3rd order tensors. Various generalizations of the Singular Value Decomposition (SVD) exist, aimed at the tensor description reduction. In this work, new approach is presented for 3rd order tensor decomposition, where unlike the famous methods for decomposition components definition, iterative calculations are not used. The basic structure unit of the new decomposition is an elementary tensor (ET) of size $2 \times 2 \times 2$, which builds the 3D tensors of size $N \times N \times N$, where $N=2^n$. The decomposition of the single ET is executed by using Hierarchical 2-level SVD, where (in each level) the SVD of size 2×2 ($SVD_{2 \times 2}$) is applied on all sub-matrices obtained after the elementary tensor unfolding. The so calculated new sub-matrices of the $SVD_{2 \times 2}$ in each hierarchical level, are rearranged in accordance with the lessening of their corresponding singular values. The computational complexity of the new tensor decomposition is lower than that of the decompositions, based on iterative methods, and permits parallel calculations for all $SVD_{2 \times 2}$ for the sub-matrices in a given hierarchical level.

Key-Words: - 3D images, tensor decomposition, Hierarchical SVD (HSVD), elementary tensor of size $2 \times 2 \times 2$.

1 Introduction

In the last years, the scientific interest aimed at the processing, analysis and recognition of 3D images, represented through tensor decomposition, was significantly increased. The basic methods for tensor decomposition [1,2,3,4] are different multilinear extensions of the matrix SVD, called Multilinear SVD (MSVD), or generalizations of the SVD matrix for higher-order tensors, called Higher-Order SVD (HOSVD). Such are the famous methods: CANDECOMP/PARAFAC (CP) or Canonical Polyadic Decomposition, where the tensor is represented as a sum of rank-one tensors; the Tucker decomposition, which is a higher-order form of the Principal Component Analysis (PCA); the Kruskal decomposition, etc. The components of the tensor decomposition are calculated by using various methods, such as, for example: the tensor power iteration; the QR-factorization, the Higher-Order Eigenvalue Decomposition (HOEVD); the Jacobi algorithm, etc. To enhance the decomposition of the 3rd order tensors, which represent sequences of 2D correlated images, in this paper is proposed non-iterative method for Hierarchical SVD (HSVD), based on the SVD of size 2×2 ($SVD_{2 \times 2}$) [5]. The basic idea is to represent the tensor decomposition of size $N \times N \times N$ (for $N=2^n$) through a hierarchical

tree-like structure of n levels. In the first hierarchical level the tensor is divided in elementary tensors (ET) of size $2 \times 2 \times 2$, transformed into matrix form, and processed with $SVD_{2 \times 2}$. The decomposition components of all matrices of size 2×2 are rearranged in accordance with the lessening of their singular values and transformed back into corresponding ET. In each consecutive hierarchical level the edges of the cubes, which represent all ETs, are increased twice, in result of which their voxels are interlaced. These increased ETs are transformed again into matrices, their sub-matrices are decomposed through $SVD_{2 \times 2}$, and rearranged following the lessening of their singular values. Then, the so obtained matrices are transformed into tensors again, etc. The essence of the new method is given in the following sections of this paper.

2 3D image representation through tensor decomposition formulation

The tensor form is suitable for the representation of 3D images, which correspond to sequences of correlated 2D images of the kind: computer tomography images, ultrasound images, multispectral and hyper spectral images of still objects, moving objects, etc. For illustration only,

on Fig. 1 is shown the 3D silhouette image sequence, represented by a 3-order tensor [1].

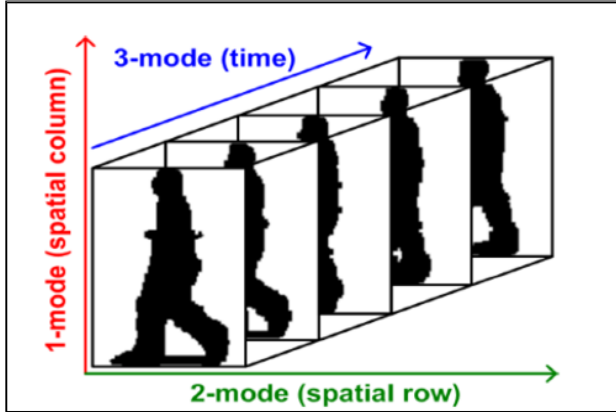

Fig. 1. 3D silhouette image sequence, represented by third-order tensor

The main advantage of the tensor representation is, that it retains to a maximum degree the correlation between the 3D-image voxels in all three orthogonal directions. As a result of the CP decomposition, each 3D tensor is represented as a sum of 3D tensors of same size, whose variances (respectively, weights) decrease rapidly. Each tensor in this sum is an outer product of 3 mutually orthogonal vectors. The aim of the tensor decomposition is to achieve full decorrelation of the sum components. Each tensor is defined by a relatively small number of parameters, and from this it follows, that the general representation of the first several tensors in the decomposition, which have maximum weight, is significantly smaller than that of the decomposed tensor. The decomposition of the kind MSVD permits to reduce the tensor representation through cutting-off the tensors with smallest weights, retaining minimum mean-square approximation error.

In this work, new approach is proposed for tensors calculation (i.e., the decomposition components), by using the HSVD. For this, in each hierarchical level, on all sub-matrices of size 2×2 , which build the transformed tensor, is applied $SVD_{2 \times 2}$. The sub-matrices are rearranged in accordance with their singular values, and the matrices, weighted this way, are transformed back into corresponding tensors (decomposition components). In the next sections of the paper is described the HSVD for 3-order tensor, based on the matrix $SVD_{2 \times 2}$.

3 SVD calculation for a matrix of size 2×2

Each matrix $[X]$ of size 2×2 could be decomposed through $SVD_{2 \times 2}$, as follows [6]:

$$\begin{aligned}
 [X] &= \begin{bmatrix} a & b \\ c & d \end{bmatrix} = \begin{bmatrix} u_{11} & u_{21} \\ u_{12} & u_{22} \end{bmatrix} \begin{bmatrix} \sigma_1 & 0 \\ 0 & \sigma_2 \end{bmatrix} \begin{bmatrix} v_{11} & v_{12} \\ v_{21} & v_{22} \end{bmatrix} = \\
 &= \sigma_1 \bar{U}_1 \bar{V}_1^t + \sigma_2 \bar{U}_2 \bar{V}_2^t = \sigma_1 \begin{bmatrix} u_{11} \\ u_{12} \end{bmatrix} \begin{bmatrix} v_{11} & v_{12} \end{bmatrix} + \sigma_2 \begin{bmatrix} u_{21} \\ u_{22} \end{bmatrix} \begin{bmatrix} v_{21} & v_{22} \end{bmatrix} = \\
 &= \frac{1}{2A} \left(\sigma_1 \begin{bmatrix} P_1 & P_2 \\ P_3 & P_4 \end{bmatrix} + \sigma_2 \begin{bmatrix} P_4 & -P_3 \\ -P_2 & P_1 \end{bmatrix} \right) = \\
 &= M \begin{bmatrix} P_1 & P_2 \\ P_3 & P_4 \end{bmatrix} + N \begin{bmatrix} P_4 & -P_3 \\ -P_2 & P_1 \end{bmatrix} = [C_1] + [C_2], \tag{1}
 \end{aligned}$$

where

$x_{11}=a, x_{12}=b, x_{21}=c, x_{22}=d$ - elements of matrix $[X]$;

$$\begin{aligned}
 M &= \sigma_1 / 2A; \quad N = \sigma_2 / 2A; \quad \sigma_1 = \sqrt{\frac{\omega + A}{2}}; \quad \sigma_2 = \sqrt{\frac{\omega - A}{2}}; \\
 \bar{U}_1 &= \frac{1}{\sqrt{2A}} \begin{bmatrix} R_1 \\ R_2 \end{bmatrix}; \quad \bar{U}_2 = \frac{1}{\sqrt{2A}} \begin{bmatrix} -R_2 \\ R_1 \end{bmatrix}; \\
 \bar{V}_1 &= \frac{1}{\sqrt{2A}} \begin{bmatrix} Q_1 \\ Q_2 \end{bmatrix}; \quad \bar{V}_2 = \frac{1}{\sqrt{2A}} \begin{bmatrix} -Q_2 \\ Q_1 \end{bmatrix}; \\
 R_1 &= \sqrt{A + \mu}; \quad R_2 = \sqrt{A - \mu}; \quad Q_1 = \sqrt{A + v}; \quad Q_2 = \sqrt{A - v}; \\
 P_1 &= R_1 Q_1; \quad P_2 = R_1 Q_2; \quad P_3 = R_2 Q_1; \quad P_4 = R_2 Q_2; \\
 A &= \sqrt{v^2 + 4\eta^2}; \quad \omega = a^2 + b^2 + c^2 + d^2; \\
 v &= a^2 + c^2 - b^2 - d^2; \quad \mu = a^2 + b^2 - c^2 - d^2; \\
 \eta &= ab + cd. \tag{2}
 \end{aligned}$$

Here σ_1 and σ_2 are the singular values of the matrix $[X]$, where $\sigma_1 \geq \sigma_2$; \bar{U}_1, \bar{U}_2 and \bar{V}_1, \bar{V}_2 are its left and right eigen vectors, for which $[X][X]^t = \lambda_s \bar{U}_s$ and $[X]^t[X] = \lambda_s \bar{V}_s$ for $s=1,2$. Here $\lambda_s = \sigma_s^2$ are the corresponding eigenvalues of the two symmetrical matrices: $[X][X]^t$ and $[X]^t[X]$.

From Eq. (1) it follows, that matrices $[C_1]$ and $[C_2]$ could be represented as follows:

$$\begin{aligned}
 [C_1] &= \frac{1}{2A} \sqrt{\frac{\omega + A}{2}} \begin{bmatrix} \sqrt{(A + \mu)(A + v)} & \sqrt{(A + \mu)(A - v)} \\ \sqrt{(A - \mu)(A + v)} & \sqrt{(A - \mu)(A - v)} \end{bmatrix}, \\
 [C_2] &= \frac{1}{2A} \sqrt{\frac{\omega - A}{2}} \begin{bmatrix} \sqrt{(A - \mu)(A - v)} & -\sqrt{(A - \mu)(A + v)} \\ -\sqrt{(A + \mu)(A - v)} & \sqrt{(A + \mu)(A + v)} \end{bmatrix}.
 \end{aligned}$$

In correspondence with Eq. (2), the elements of $[C_1]$ and $[C_2]$ are defined by the four parameters $\omega, v, \mu,$

and η , i.e., the decomposition, represented by Eq. (1), is not “overcomplete”.

4 Calculation of the Hierarchical SVD for tensor of size $2 \times 2 \times 2$

The tensor of size $2 \times 2 \times 2$, noted as $T_{2 \times 2 \times 2}$, is the kernel of the decomposition for the 3rd-order tensor of size $N \times N \times N$ for $N=2^n$. After mode-1 unfolding (or matricization) the elementary tensor $T_{2 \times 2 \times 2}$, is obtained:

$$\text{unfold}(T_{2 \times 2 \times 2}) = \begin{bmatrix} a & b & e & f \\ c & d & g & h \end{bmatrix} = [X_1] \quad [X_2] \quad (3)$$

In the first level of the HSVD algorithm for the tensor $T_{2 \times 2 \times 2}$ (HSVD $_{2 \times 2 \times 2}$), on each of the matrices $[X_1]$ and $[X_2]$ is applied SVD of size 2×2 (SVD $_{2 \times 2}$), and in result is got:

$$[X_1] = \begin{bmatrix} a & b \\ c & d \end{bmatrix} = [C_{11}] + [C_{12}], \quad (4)$$

$$[X_2] = \begin{bmatrix} e & f \\ g & h \end{bmatrix} = [C_{21}] + [C_{22}]$$

The so obtained matrices $[C_{i,j}]$ of size 2×2 for $i,j=1,2$ in Eq. (4) are rearranged in new couples in correspondence to their singular values. After the rearrangement, the first couple of matrices $[C_{11}]$ and $[C_{21}]$, which have high singular value, defines the tensor $T_{1(2 \times 2 \times 2)}$ by reverse matricization, and the second couple $[C_{12}]$ and $[C_{22}]$ which have lower singular value - the tensor $T_{2(2 \times 2 \times 2)}$. Then:

$$T_{2 \times 2 \times 2} = T_{1(2 \times 2 \times 2)} + T_{2(2 \times 2 \times 2)} \quad (5)$$

After mode-3 unfolding of both tensors, is obtained:

$$\begin{aligned} & \text{unfold}(T_{1(2 \times 2 \times 2)}) + \text{unfold}(T_{2(2 \times 2 \times 2)}) = \\ & = [[X_{11}] \quad [X_{21}]] + [[X_{12}] \quad [X_{22}]] \end{aligned} \quad (6)$$

In the second level of HSVD $_{2 \times 2 \times 2}$, on each matrix $[X_{i,j}]$ of size 2×2 is applied SVD $_{2 \times 2}$ and in result is got:

$$\begin{aligned} [X_{11}] &= [C_{111}] + [C_{112}], \quad [X_{21}] = [C_{211}] + [C_{212}], \\ [X_{12}] &= [C_{121}] + [C_{122}], \quad [X_{22}] = [C_{221}] + [C_{222}]. \end{aligned} \quad (7)$$

The so calculated matrices $[C_{i,j,k}]$ of size 2×2 for $i,j,k=1,2$ are rearranged into 4 new couples with similar singular values in order, defined by its decrease. Each of these 4 couples of matrices by reverse matricization defines a corresponding tensor

of size $2 \times 2 \times 2$. After their mode-1 unfolding, is obtained:

$$\begin{aligned} & \text{unfold}\{T_{1(2 \times 2 \times 2)}(1)\} + \text{unfold}\{T_{1(2 \times 2 \times 2)}(2)\} + \\ & + \text{unfold}\{T_{2(2 \times 2 \times 2)}(1)\} + \text{unfold}\{T_{2(2 \times 2 \times 2)}(2)\} = \\ & = [[C_{111}] \quad [C_{211}]] + [[C_{121}] \quad [C_{221}]] + \\ & + [[C_{112}] \quad [C_{212}]] + [[C_{122}] \quad [C_{222}]] \end{aligned} \quad (8)$$

In result of the execution of the two levels of the HSVD $_{2 \times 2 \times 2}$, the tensor $T_{2 \times 2 \times 2}$ is represented as:

$$\begin{aligned} T_{2 \times 2 \times 2} &= T_{1(2 \times 2 \times 2)}(1) + T_{1(2 \times 2 \times 2)}(2) + T_{2(2 \times 2 \times 2)}(1) + T_{2(2 \times 2 \times 2)}(2) = \\ &= \sum_{i=1}^2 \sum_{j=1}^2 T_{j(2 \times 2 \times 2)}(i). \end{aligned} \quad (9)$$

On Fig. 2 is shown the decomposition algorithm for the elementary tensor $T_{2 \times 2 \times 2}$. After the decomposition, the tensors in the sum are arranged in correspondence to the lessening of the σ_s values for the sub-matrices, obtained through unfolding all tensors in the sum. The voxels with largest tensor values are coloured in red, and the smallest - in blue.

On Fig. 3 is shown the calculation graph of the 2-level HSVD algorithm for the elementary tensor $T_{2 \times 2 \times 2}$, based on the multiple calculation of SVD $_{2 \times 2}$ in each hierarchical level.

After the execution of the calculations for a given level, the elements of the sub-matrices obtained for the SVD $_{2 \times 2}$ are rearranged in accordance with the lessening of the σ_s values, and are transformed back into new elementary tensors: two tensors $T_{1(2 \times 2 \times 2)}$ and $T_{2(2 \times 2 \times 2)}$ - after the end of the first level, and four tensors $T_{11(2 \times 2 \times 2)}$, $T_{12(2 \times 2 \times 2)}$, $T_{21(2 \times 2 \times 2)}$ and $T_{22(2 \times 2 \times 2)}$ - after the second level.

5 Calculation of the HSVD for tensor of size $4 \times 4 \times 4$ and $8 \times 8 \times 8$

In the first level of the HSVD $_{4 \times 4 \times 4}$ algorithm the tensor $T_{4 \times 4 \times 4}$ (for $N=4$), shown on Fig. 4, is divided into eight elementary tensors $T_{2 \times 2 \times 2}(i)$ for $i=1,2,\dots,8$ (cubes of size $2 \times 2 \times 2$). In accordance with this algorithm, each elementary tensor is decomposed into 4 new tensors $T_{j(2 \times 2 \times 2)}(i)$ for $j=1,2,3,4$ of same size. In the 1st level of HSVD $_{4 \times 4 \times 4}$, on each tensor $T_{j(2 \times 2 \times 2)}(i)$ composed of 8 voxels of same colour (yellow, red, green, blue, white, purple, light blue, and orange), is applied HSVD $_{2 \times 2 \times 2}$. After the rearrangement of the elementary tensors, and their integration, are obtained four new 4 tensors $T_{j(4 \times 4 \times 4)}(i)$.

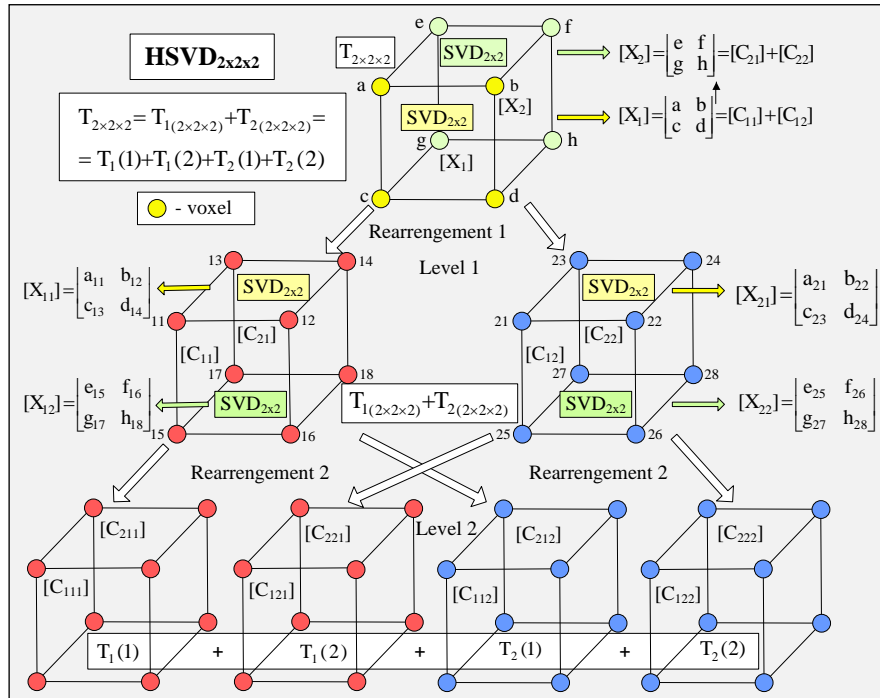

Fig. 2. Two-level HSVD_{2x2x2} algorithm for elementary tensor of size 2x2x2 based on the SVD_{2x2}

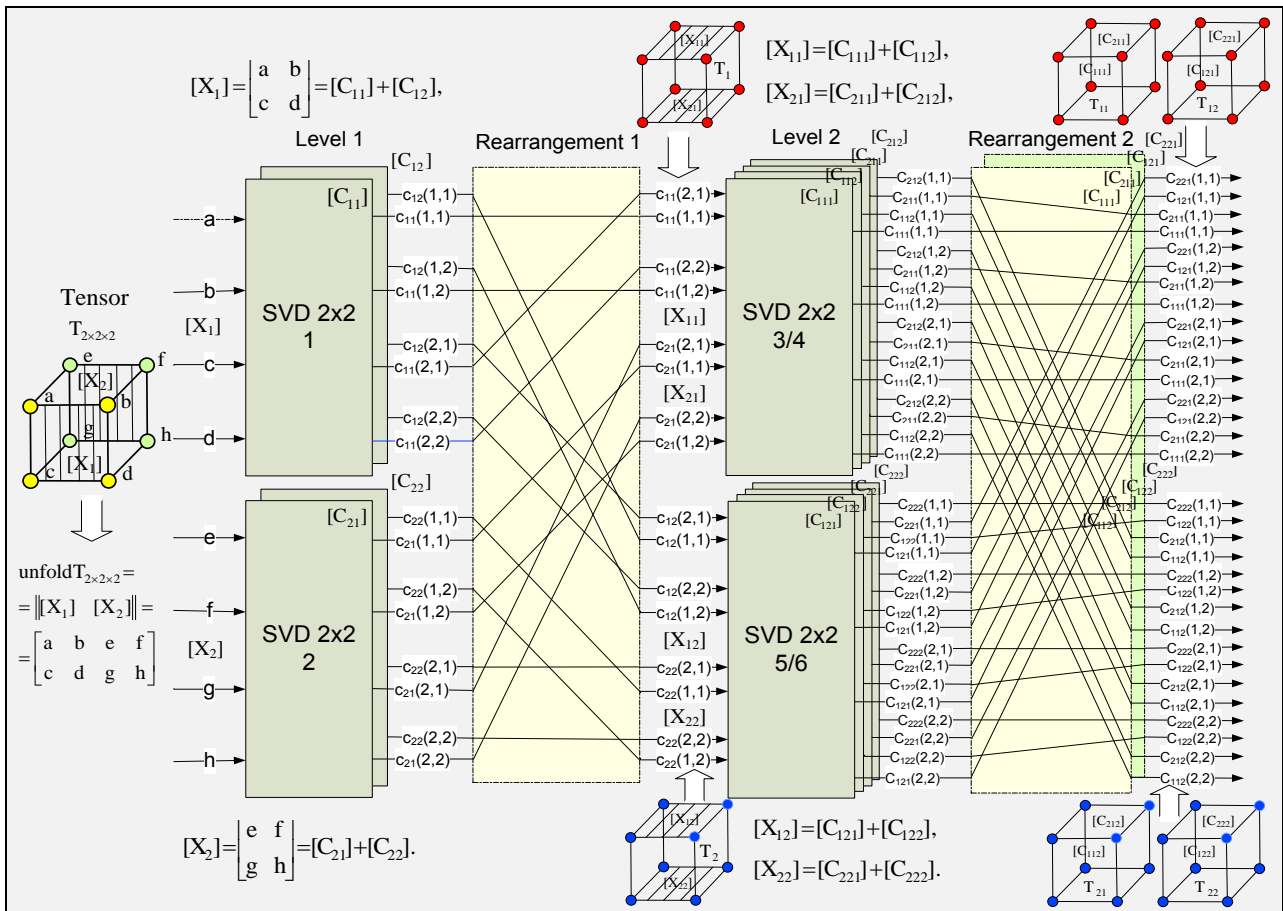

Fig. 3. The flow graph of the 2-level HSVD for the elementary tensor $T_{2 \times 2 \times 2}$, based on the SVD_{2x2}

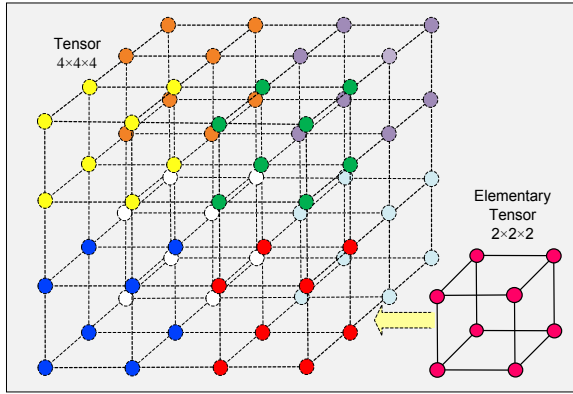

Fig. 4. The tensor $T_{4 \times 4 \times 4}$ is divided into eight elementary tensors $T_{2 \times 2 \times 2}(i)$ for $i=1,2,\dots,8$ in the first $HSVD_{4 \times 4 \times 4}$ level, where the $HSVD_{2 \times 2 \times 2}$ is applied on each group of voxels of same color (8 in total)

In the second level of the $HSVD_{4 \times 4 \times 4}$ algorithm each of the four tensors $T_{j(4 \times 4 \times 4)}(i)$ is divided into eight sub-tensors $T_{i,k(2 \times 2 \times 2)}(j)$ for $i=1,2, j=1,2$ and $k=1,2$ in the way, defined by the spatial net for voxel interlacing as shown on Fig. 5. The colour of the voxels in each cube corresponds to that from the first level of the $HSVD_{4 \times 4 \times 4}$ algorithm. On each expanded elementary tensor (double size tensor), shown on Fig. 5, is applied once again the $HSVD_{2 \times 2 \times 2}$ algorithm.

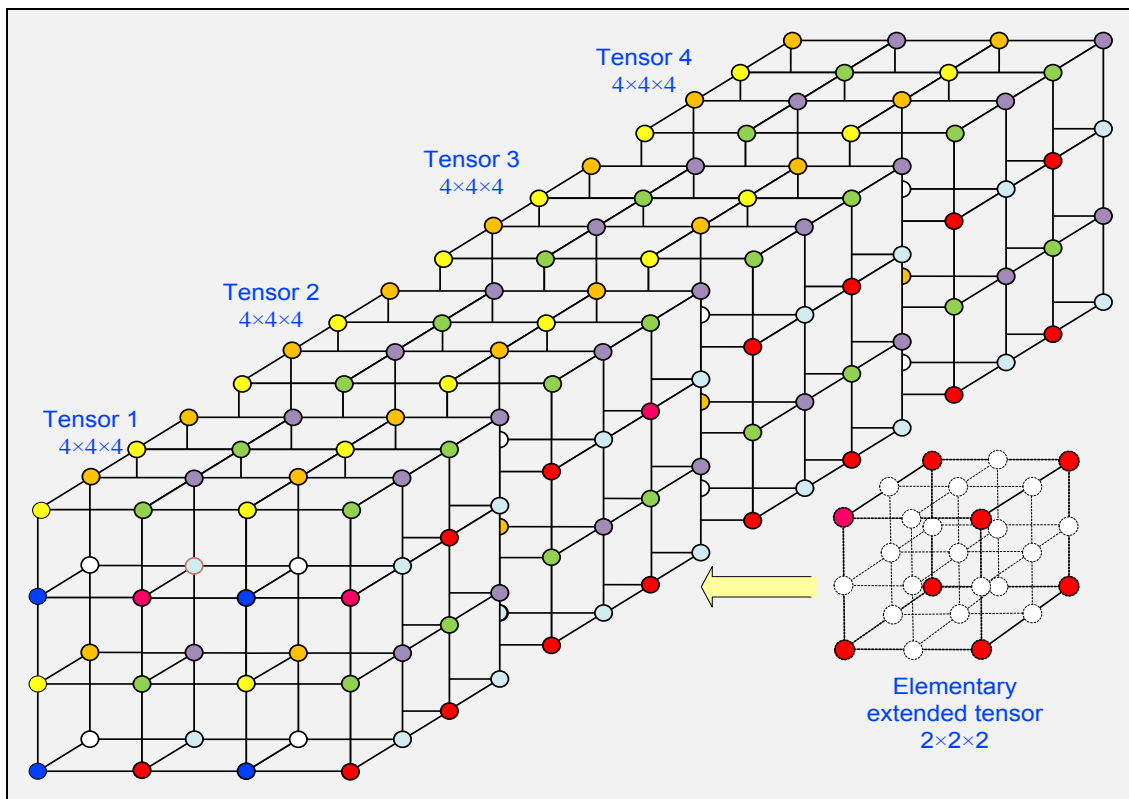

Fig. 5. Division of tensors $T_{i(4 \times 4 \times 4)}(j)$ into the elementary tensors $T_{j(2 \times 2 \times 2)}(i)$ in the second $HSVD_{4 \times 4 \times 4}$ level, where the $HSVD_{2 \times 2 \times 2}$ is applied on each group of voxels of same color (32 in total)

After the execution of the 1st decomposition level, the tensor $T_{4 \times 4 \times 4}$ is represented as a sum of 4 components:

$$T_{4 \times 4 \times 4} = \sum_{i=1}^2 \sum_{j=1}^2 T_{j(4 \times 4 \times 4)}(i) \quad (10)$$

The so calculated 4 tensors $T_{i(4 \times 4 \times 4)}(j)$ are arranged in correspondence with the lessening of the mean singular values (the energy) of the elementary tensors $T_{i,k(2 \times 2 \times 2)}(j)$, for $i=1,2, j=1,2, k=1,2$. The tensors $T_{i(4 \times 4 \times 4)}(j)$ are rearranged in accordance with

the energy decrease of the ETs $T_{i,k(2 \times 2 \times 2)}(j)$, which build them. In accordance with Fig. 2, on each ET is applied the two-level $HSVD_{2 \times 2 \times 2}$ again. After the execution of the second decomposition level, the tensor $T_{4 \times 4 \times 4}$ is represented as a sum of 16 components:

$$T_{4 \times 4 \times 4} = \sum_{i=1}^4 \sum_{j=1}^4 T_{j(4 \times 4 \times 4)}(i) \quad (11)$$

The computational graph of the 2-level $HSVD_{4 \times 4 \times 4}$ decomposition is shown on Fig. 6.

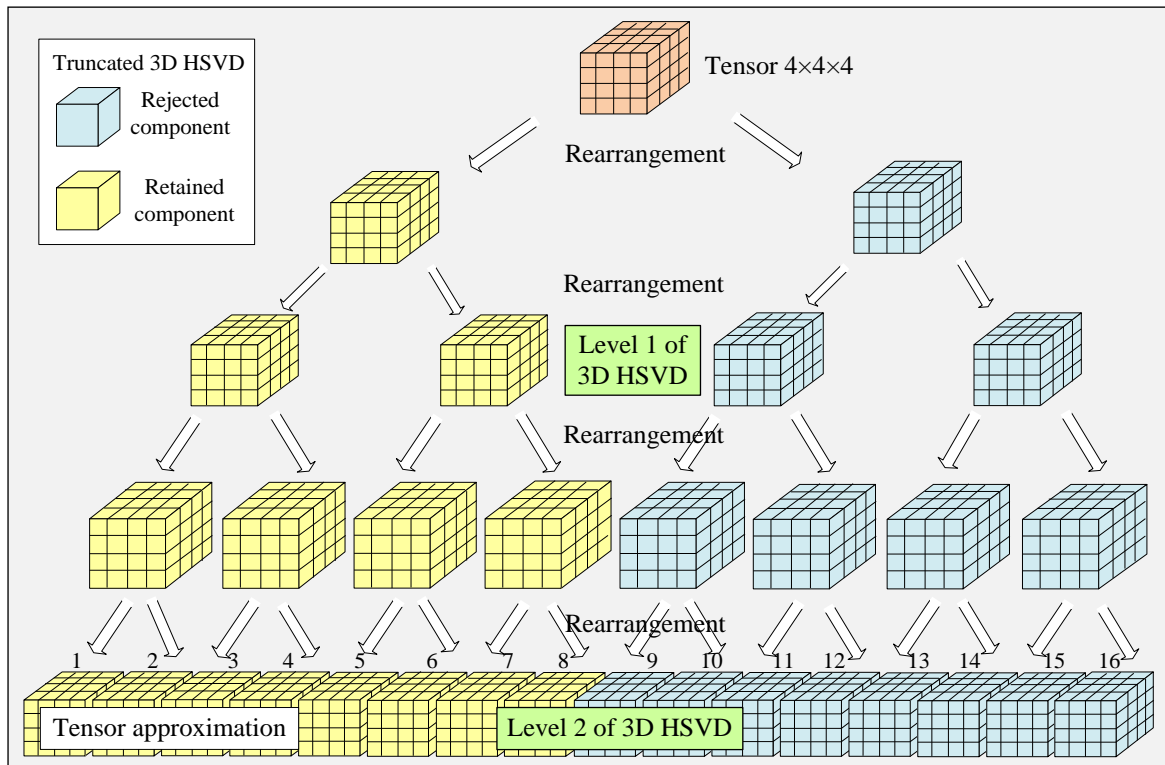

Fig.6. Structure of the computational graphs of the full and truncated 4-level binary tree for the execution of the 2-level 3D HSVD_{4x4x4} algorithm based on the SVD_{2x2}

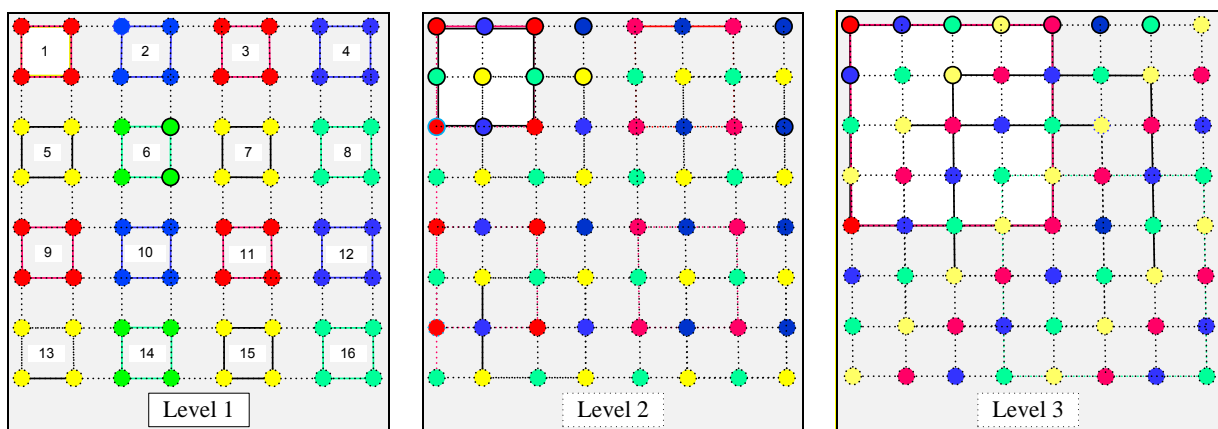

Fig.7. Section for tensor of size 8x8x8 in levels 1, 2, and 3 of the 3-level HSVD_{8x8x8} algorithm, based on the SVD_{2x2} (each tensor here is represented as a matrix of size 8x8; in each level, the SVD_{2x2} is executed 16 times)

The so calculated 16 tensors $T_{j(4 \times 4 \times 4)}(i)$ are arranged in accordance with the decreasing values of the singular values of kernels, $T_{i,k(2 \times 2 \times 2)}(j)$, which compose them, for $i=1,2, j=1,2$ and $k=1,2$. In the 1st level of the full HSVD_{4x4x4}, the HSVD_{2x2x2} is executed 8 times, and in the 2nd level - 32 times. In the case, when the tensor is of size 8x8x8, the corresponding HSVD_{8x8x8} algorithm if of 3 levels: in the first level are obtained 4 tensors of same size; in the second - 16 tensors, and in the last, third level - 64 tensors.

On Fig. 7 are shown the corresponding sections of the initial tensor in the first decomposition level, and of one tensor in the second and third levels. In the second level are shown only 8 of the submatrices of size 2x2, on which is applied the SVD_{2x2}, and in the third level - only four of the submatrices of size 2x2. The elements of each submatrix are coloured in same colour: red, green, blue, yellow.

6 General HSVD case for a tensor of size $N \times N \times N$

The decomposition of tensors $T_{4 \times 4 \times 4}$ and $T_{8 \times 8 \times 8}$ could be generalized for the case, when the tensor $T_{N \times N \times N}$ is of size $N \times N \times N$ for $N=2^n$. As a result of the use of the HSVD $_{N \times N \times N}$ algorithm, the tensor $T_{2^n \times 2^n \times 2^n}$ is represented as a sum of $N^2=2^{2n}$ singular tensors:

$$T_{2^n \times 2^n \times 2^n} = \sum_{i=1}^{2^n} \sum_{j=1}^{2^n} T_{j(2^n \times 2^n \times 2^n)}(i). \quad (12)$$

The singular tensors $T_{j(2^n \times 2^n \times 2^n)}(i)$ of size $2^n \times 2^n \times 2^n$ are arranged in accordance with the decreasing values of the energies of $T_{i,k(2 \times 2 \times 2)}(j)$ for $i, j, k = 1, 2, \dots, 2^n$, which build them. The number of hierarchical levels needed for the execution of the HSVD $_{N \times N \times N}$ algorithm for $N=2^n$, is n .

7 Example for tensor decomposition of size $2 \times 2 \times 2$

Let the voxels of the elementary tensor $T_{2 \times 2 \times 2}$, represented in correspondence with Eq. (3), have the values: $a=a, b=a, c=b, e=a, f=b, j=b, h=a$. Then Eq. (3) becomes:

$$\text{unfold}(T_{2 \times 2 \times 2}) = \begin{bmatrix} a & a & a & b \\ b & b & b & a \end{bmatrix} = \begin{bmatrix} [X_1] & [X_2] \end{bmatrix}$$

After applying the SVD $_{2 \times 2}$ on each of the matrices $[X_1]$ and $[X_2]$, is obtained:

$$[X_1] = \begin{bmatrix} a & a \\ b & b \end{bmatrix} = [C_{11}] + [C_{12}], [X_2] = \begin{bmatrix} a & b \\ b & a \end{bmatrix} = [C_{21}] + [C_{22}]$$

where:

$$[C_{11}] = \begin{bmatrix} a & a \\ b & b \end{bmatrix}, [C_{12}] = \begin{bmatrix} 0 & 0 \\ 0 & 0 \end{bmatrix}, [C_{21}] = \frac{a+b}{2} \begin{bmatrix} 1 & 1 \\ 1 & 1 \end{bmatrix},$$

$$[C_{22}] = \frac{a-b}{2} \begin{bmatrix} 1 & -1 \\ -1 & 1 \end{bmatrix},$$

After the rearrangement of the voxels of the tensors $T_{1(2 \times 2 \times 2)}$ and $T_{2(2 \times 2 \times 2)}$ composed by the matrices $[C_{11}], [C_{12}], [C_{21}], [C_{22}]$, followed by mode-3 unfolding of both tensors, the next four matrices are obtained:

$$[X_{11}] = \begin{bmatrix} a & \frac{a+b}{2} \\ a & \frac{a+b}{2} \end{bmatrix}; [X_{12}] = \begin{bmatrix} b & \frac{a+b}{2} \\ b & \frac{a+b}{2} \end{bmatrix};$$

$$[X_{21}] = \begin{bmatrix} 0 & \frac{a-b}{2} \\ 0 & \frac{a-b}{2} \end{bmatrix}; [X_{22}] = \begin{bmatrix} 0 & \frac{a-b}{2} \\ 0 & \frac{a-b}{2} \end{bmatrix}.$$

On each of these matrices is then applied once more SVD $_{2 \times 2}$, and as a result is obtained:

$$[X_{11}] = [C_{111}] + [C_{112}], [X_{21}] = [C_{211}] + [C_{212}], [X_{12}] = [C_{121}] + [C_{122}], [X_{22}] = [C_{221}] + [C_{222}],$$

where

$$[C_{111}] = \begin{bmatrix} a & a \\ b & b \end{bmatrix}, [C_{211}] = \frac{a+b}{2} \begin{bmatrix} 1 & 1 \\ 1 & 1 \end{bmatrix},$$

$$[C_{221}] = \frac{a-b}{2} \begin{bmatrix} 1 & 1 \\ 1 & 1 \end{bmatrix},$$

$$[C_{121}] = [C_{112}] = [C_{212}] = [C_{122}] = [C_{222}] = \begin{bmatrix} 0 & 0 \\ 0 & 0 \end{bmatrix}.$$

The values of the voxels of tensors $T_1(1), T_1(2), T_2(1)$, and $T_2(2)$ (each of size $2 \times 2 \times 2$), composed by the matrices $[C_{111}], [C_{112}], [C_{211}], [C_{212}], [C_{121}], [C_{122}], [C_{221}], [C_{222}]$, are given on Fig. 8. In this case, the voxels coloured in red only (12 in total), have nonzero values. The remaining 20 voxels, coloured in blue (half of these, corresponding to the second tensor, and all voxels of the third and fourth tensors in the decomposition) have nonzero values.

8 Evaluation of the decomposition components energy, and their mutual correlation

8.1. Tensor energy

The energy of each tensor, represented by the decomposition (12), is defined by the relation:

$$P_T = \sum_{i=1}^N \sum_{j=1}^N \sum_{k=1}^N t^2(i, j, k) = \sum_{s=1}^{N^2} P_{T_s}, \quad (13)$$

where $t(i, j, k)$ are the voxels of the tensor T , and P_{T_s} is the energy of each tensor T_s for $s=1, 2, \dots, N^2$, in accordance with Eq. (12). In the case for $N=2$, the energy of the tensors T_s for $s=1, 2, 3, 4$ is defined by the relations:

$$P_{T_1} = a^2 + a^2 + b^2 + b^2 + (a+b)^2 = 3(a^2 + b^2) + 2ab;$$

$$P_{T_2} = (a-b)^2; P_{T_3} = P_{T_4} = 0. \quad (14)$$

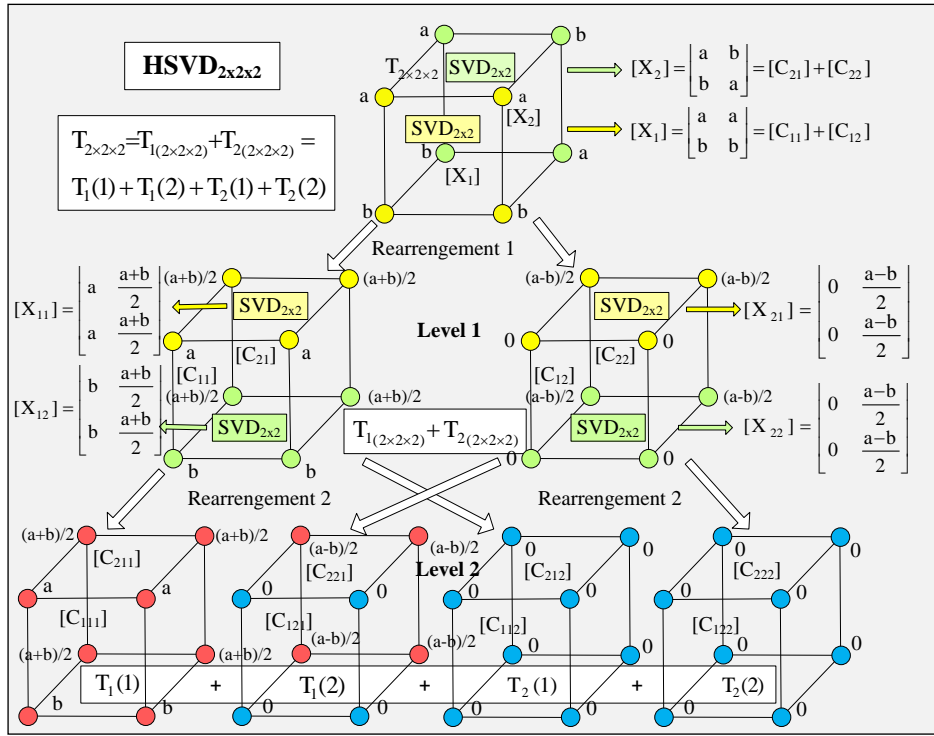

Fig. 8. Example: two-level HSVD_{2x2x2} for elementary tensor T_{2x2x2}

To evaluate the energy (P_{T_1}) of the first tensor in the decomposition, regarding the total energy (P_T) could be used the relation below:

$$\eta = P_{T_1} / \sum_{s=1}^4 P_{T_s} = \frac{3(a^2 + b^2) + 2ab}{4(a^2 + b^2)} = \frac{3}{4} + \frac{1}{2(a/b + b/a)}. \quad (15)$$

If $a=4$ and $b=2$ is obtained $\eta=0.95$, i.e. 95% of the total energy of the tensor $T_{2 \times 2 \times 2}$ are concentrated in the first decomposition tensor, T_1 . In particular, if $a=b$, then $\eta=1$ and in the first tensor is concentrated the total energy (100%), for any value of a .

8.2. Mutual correlation

The mutual correlation between couples of decomposition tensors $R(T_p, T_{p+1})$ is defined by their scalar product:

$$R(T_p, T_{p+1}) = \sum_{i=1}^N \sum_{j=1}^N \sum_{k=1}^N t_p(i, j, k) t_{p+1}(i, j, k). \quad (16)$$

For the example from Fig. 7 the mutual correlation $R(T_p, T_{p+1})$ for $p=1,2,3$ between tensor couples, is correspondingly:

$R(T_1, T_2) = (a^2 - b^2)$; $R(T_2, T_3) = R(T_3, T_4) = 0$, i.e., it rapidly decreases to zero. This result shows that the so obtained tensor components in the decomposition are significantly decorrelated.

The Normalized Correlation Function (NCF) in respect of the first one, is:

$$\rho(T_1, T_{1+s}) = \frac{R(T_1, T_{1+s})}{R(T_1, T_1)} = \begin{cases} 1 & \text{for } s = 0; \\ \frac{(a^2 - b^2)}{3(a^2 + b^2)} & \text{for } s = 1; \\ 0 & \text{for } s = 2, 3. \end{cases} \quad (17)$$

For the case, when $a=4$ and $b=2$, on Fig. 9 is shown the graphic representation of the function $\rho(s)$.

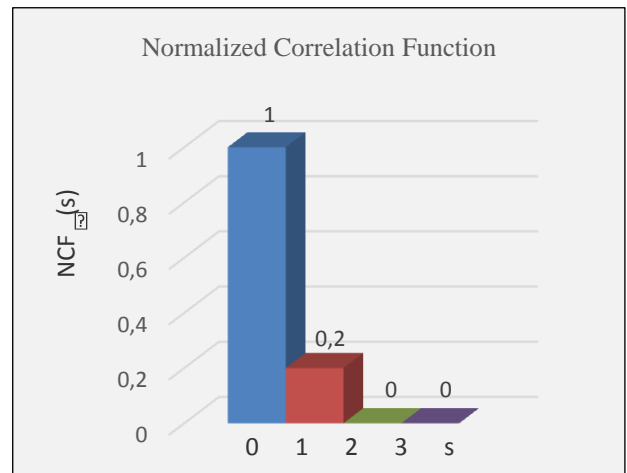

Fig. 9. The Normalized Correlation Function of the decomposition components

9 Computational complexity of the new hierarchical tensor decomposition

In correspondence with [6], the computational complexity of new algorithm for decomposition of the tensor $[T_{2^n \times 2^n \times 2^n}]$, is $O(2^{4n})$. The comparison with the H-Tucker tensor decomposition $O(3 \times 2^{3n} + 3 \times 2^{4n})$ shows, that for the new decomposition it is approximately 3 times lower. But, the needed memory should be about 1/3 larger, than that for the H-Tucker tensor decomposition.

10 Conclusions

The basic advantages of the new approach for calculation of the hierarchical tensor decomposition, used to represent 3D images of various kind, are as follows:

- The offered HSVD algorithm, unlike the H-Tucker tensor decomposition, has lower computational complexity and does not need iterative calculations;
- In accordance with Eqs. (3) and (9), in each hierarchical level is executed repeatedly same decomposition of elementary tensors of size $2 \times 2 \times 2$, which permits their parallel calculation;
- The comparison with the famous tensor decompositions shows, that the HSVD algorithm opens new and better abilities to enhance the efficiency of the systems for real-time processing of 3D images, and also in the 3D computer vision systems and 3D objects recognition.

References:

- [1] H. Lu, K. Plataniotis, A. Venetsanopoulos, MPCA: Multilinear Principal Component Analysis of Tensor Objects, *IEEE Transactions on Neural Networks*, Vol. 19, No 1, January 2008, pp. 18-39.
- [2] G. Bergqvist, E. Larsson, The Higher-Order Singular Value Decomposition: Theory and an Application, *IEEE Signal Processing Magazine*, Vol. 27, Iss. 3, 2010, pp. 151-154.
- [3] A. Cichocki, D. Mandic, A. Phan, C. Caiafa, G. Zhou, Q. Zhao, L. De Lathauwer, Tensor Decompositions for Signal Processing Applications, *IEEE Signal Processing Magazine*, Vol. 32, Iss. 2, 2015, pp. 145-163.
- [4] L. De Lathauwer, B. De Moor, and J. Vandewalle, A Multilinear Singular Value Decomposition, *SIAM Journal of Matrix Analysis and Applications*, Vol. 24, 2000, pp. 1253–1278.
- [5] R. Kountchev, R. Kountcheva, Radix- (2×2) Hierarchical SVD for multi-dimensional images, *Proc. of the IEEE Intern. Conf. on Telecommunications in Modern Satellite, Cable and Broadcasting Services (TELSIKS'15)*, Nis, Serbia, Oct. 2015, pp. 45-55.
- [6] R. Kountchev, R. Kountcheva, Hierarchical Decomposition of 2D/3D Images, based on SVD 2×2 , *International J. of Multimedia and Image Processing (IJMIP)*, Vol. 5, Iss. 3/4, September/December 2015, pp. 286-296.