

Fault Tolerant Direct Torque Control of Three-Phase Permanent Magnet Synchronous Motors

QINGFANG TENG¹, JIANGUO ZHU², TIANSHI WANG², GANG LEI²

¹Department of Automation and Electrical Engineering
Lanzhou Jiaotong University
Lanzhou, Gansu, 730070
P.R.CHINA

²Faculty of Engineering and Information Technology
University of Technology Sydney
Sydney, NSW, 2007
AUSTRALIA

tengqf@mail.lzjtu.cn <http://www.lzjtu.edu.cn>

Abstract: - The model of three-phase permanent magnet synchronous motor (PMSM) with loss of one phase or loss of one transistor is built and its fault tolerant direct torque control (DTC) is investigated. Extra-leg extra-switch inverter is put to use in the post-fault operation. Two different flux estimators are employed in order to calculate stator flux linkage & their corresponding torque and switching table is kept the same as the case of DTC for the healthy motor. The parameters of PI controller and hysteresis controller are determined by differential evolution algorithm. Dynamic responses of both healthy and unhealthy PMSM DTC system adopting aforementioned two flux estimators are given to compare their performance via simulation and some discussion is presented. The simulation results show the proposed fault tolerant DTC yields satisfactory torque and speed control no matter which one of two flux estimators provided in the paper is employed.

Key-Words: - Fault tolerant control; Direct torque control; Permanent magnet synchronous motor; Motor model; Flux estimator; Inverter

1 Introduction

The electrical drive systems of modern automotive and aerospace must be required to be high reliable and safe. Due to a variety of complex factors, potential failures are often inevitable. Once the electrical drive is out of order, if repairs and maintenance cannot be completed on the spot, this will result in the system to stop working, may cause great financial losses, and even result in enormous human and property losses. Therefore, there is an urgent need to research fault control for electrical motor.

One of the most common types of potential faults in electrical motor is the loss of one phase (LOP) of the motor, or alternatively, the loss of one transistor (LOT) in legs of the inverter. If LOP or LOT happens suddenly, the corresponding phase is open-circuited, supply and load currents are significantly distorted and the load phase current in which the failure occurred has large zero periods resulting in a loss of torque control and in high pulsating unacceptably torques. Consequently, the drive system's operation has to be interrupted [1, 2]. So it

is indispensable to solve the problem such that motor system is controlled to be disturbance-free.

As for the aforementioned fault, nowadays there are two modulation techniques, one being based-on hardware techniques and the other based-on software. By means of some different approaches such as using matrix converter structure[3,4], adding redundant switch [1,5-7], introducing phase-redundant topology [8-10], proposing cascaded two-level converter [11] as well as giving redundant converter[12,13], etc., the effective fault tolerant results have been achieved. However, these methods are less preferable in some applications because of complicated hardware and high operation cost. Therefore the fault tolerant method using software with low-cost reconfiguration has been highly praising [14-17]. Over the past years, making use of field oriented control strategy (FOC) [18], the performance of faulty electric drive systems can be maintained via controlling current [2,10,19-21]. Due to high performance of direct torque control (DTC), it has recently begun to be applied to electrical motor [22,23].

Permanent magnet synchronous motor (PMSM) drive is nowadays widely used in the industry applications due to their high efficiency and high power/torque density. For healthy three-phase PMSM inverter, Fig.1 is its topology. For unhealthy three-phase PMSM with LOP or LOT fault, there are mainly three solving schemes at present: the first is called the extra-leg split capacitor control strategy [2, 24], which adds a redundant switch to connect the source's neutral to the load's neutral. The second is known as split capacitor scheme for isolating the phase with a faulty switching device of motor drive system and connecting to the midpoint of DC link [25]. The disadvantage of aforementioned two reconfiguration topologies lie in that the maximum speed in the post-fault operation is half of its nominal value due to the applied voltage on the machine terminals is decreased to half of its original value. Then appears the third termed as extra-leg extra-switch (ELES) scheme shown in Fig.2. In the scheme, the added switch connects the motor neutral point to an extra inverter leg, which provides the current path during the fault operation.

Based-on the third scheme, employing voltage & current model flux estimator, [22,23] discussed fault tolerant DTC for PM AC motor with one phase open-circuit fault. To go further more, using two different flux-linkage estimators, this paper investigates fault tolerant DTC for PMSM. The largest difference between this paper and [22,23] is that the latter need to change the switch table, while the former doesn't do, i.e., the switching table adopted in this paper is the same as one for healthy three phase motor. It will be shown that using the method developed in this paper, the reliability and satisfactory performance can be achieved for the drive system under LOP or LOT operating condition.

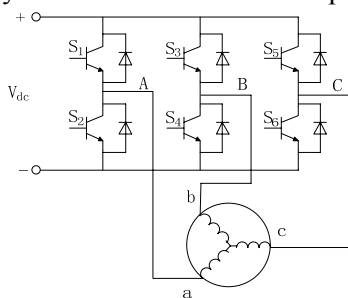

Fig. 1 Healthy three phase inverter

The paper consists of five sections: modeling of PMSM with LOP or LOT is presented in section two. By means of two different flux linkage estimators and their corresponding torque estimators, section three gives fault tolerant DTC for PMSM

with LOP or LOT. Simulation results & discussion and conclusion are reported in section four and five.

2 Model of PMSM with LOP or LOT in abc-System

In this paper, as for three phase PMSM, its phase *a* is assumed to be off. Schematic diagram of the motor-inverter is shown in Fig. 2. Like the process of building model [26] for healthy motor, modeling of unhealthy motor includes three equations: flux linkage, voltage and torque equation.

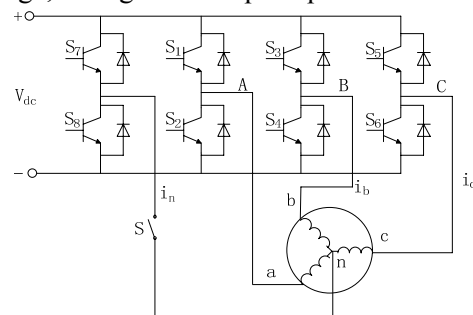

Fig.2 ELES three phase inverter

2.1 Stator flux-linkage expression in abc-system

Suppose three-phase stator self-inductances L_a , L_b and L_c are same, i.e. $L_a=L_b=L_c=L$ and three-phase stator mutual-inductances M_{ab} , M_{bc} and M_{ca} are same, i.e. $M_{ab}=M_{bc}=M_{ca}=M$ (neglecting stator self-inductance's and mutual-inductance's second harmonics). And i_b and i_c are stator phase currents. When phase *a* is off, stator flux-linkages Ψ_{sa} , Ψ_{sb} and Ψ_{sc} produced only by the stator currents in *abc*-system (that means three-phase stationary coordinate) are shown as in Fig. 3 and can be expressed as follows:

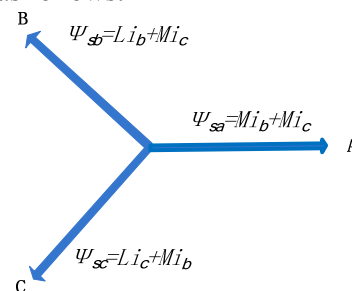

Fig. 3 Flux-linkages of three phases produced by stator currents in abc-system

$$\begin{bmatrix} \Psi_{sa} \\ \Psi_{sb} \\ \Psi_{sc} \end{bmatrix} = \begin{bmatrix} M & M \\ L & M \\ M & L \end{bmatrix} \begin{bmatrix} i_b \\ i_c \end{bmatrix} \quad (1)$$

Considering the rotor magnet, the stator flux-linkage vector in *abc*-system can be expressed as follows:

$$\begin{bmatrix} \Psi_a \\ \Psi_b \\ \Psi_c \end{bmatrix} = \begin{bmatrix} \Psi_{sa} \\ \Psi_{sb} \\ \Psi_{sc} \end{bmatrix} + \begin{bmatrix} \Psi_m \cos \theta_r \\ \Psi_m \cos(\theta_r - \frac{2\pi}{3}) \\ \Psi_m \cos(\theta_r + \frac{2\pi}{3}) \end{bmatrix} \quad (2)$$

Where Ψ_a, Ψ_b and Ψ_c are resultant of stator flux-linkages produced both by the stator currents and by the rotor magnetic along *a*-axis, *b*-axis and *c*-axis, respectively. θ_r and Ψ_m are electrical angular rotor position with reference to phase *a* and permanent magnet flux, respectively.

2.2 Stator voltage equation in *abc*-system

When phase *a* is off, stator voltage vector of PMSM is given by:

$$\begin{bmatrix} V_a \\ V_b \\ V_c \end{bmatrix} = \begin{bmatrix} 0 & 0 \\ R_b & 0 \\ 0 & R_c \end{bmatrix} \begin{bmatrix} i_b \\ i_c \end{bmatrix} + \frac{d}{dt} \begin{bmatrix} \Psi_a \\ \Psi_b \\ \Psi_c \end{bmatrix} \quad (3)$$

Where V_a, V_b and V_c are stator voltages, R_b, R_c are stator resistances.

Neglecting V_a and substituting (2) into (3), we can get following expression,

$$\begin{bmatrix} V_b \\ V_c \end{bmatrix} = \begin{bmatrix} R_b & 0 \\ 0 & R_c \end{bmatrix} \begin{bmatrix} i_b \\ i_c \end{bmatrix} + \begin{bmatrix} L & M \\ M & L \end{bmatrix} \begin{bmatrix} \frac{di_b}{dt} \\ \frac{di_c}{dt} \end{bmatrix} - \begin{bmatrix} \Psi_m \omega_r \sin(\theta_r - \frac{2\pi}{3}) \\ \Psi_m \omega_r \sin(\theta_r + \frac{2\pi}{3}) \end{bmatrix} \quad (4)$$

where ω_r is rotor speed, the phase currents i_b, i_c and neutral line current i_n in Fig. 2 meet following mathematical relationship

$$i_n = i_b + i_c \quad (5)$$

2.3 Electromagnetic torque equation

The electromagnetic torque equation of PMSM with LOP or LOT fault is as follows,

$$J \frac{d\omega_r}{dt} = T_e - T_l - B_m \omega_r - T_f \quad (6)$$

where J, T_e, T_l, B_m and T_f are respectively inertia of moment, electromagnetic torque, load torque, viscous friction coefficient and coulomb friction torque.

Combination of the above-given flux-linkage vector equation, phase voltage vector equation and electromagnetic torque equation is the model for PMSM with LOP or LOT.

3 Fault Tolerant DTC for PMSM with LOP or LOT

The objective of fault tolerant DTC for PMSM is that when LOP or LOT failure happens, motor speed and torque still can be controlled to meet given requirements. The block diagram of fault tolerant DTC for PMSM with LOP or LOT is shown in Fig.4. It mainly comprises of power unit and DTC component. The power unit adopts ELES inverter structure as shown in Fig.2. DTC includes flux and torque estimators, switching table, PI controller and hysteresis controller.

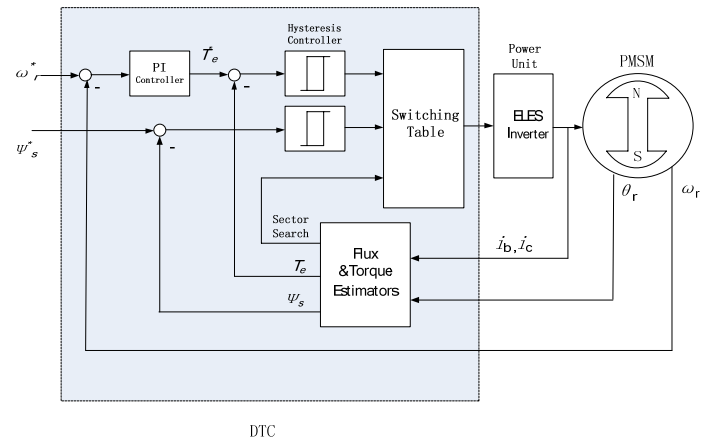

Fig. 4 Fault tolerant DTC for PMSM

3.1 Flux and torque estimators

Generally, voltage model flux estimator and current model flux estimator can be employed in DTC algorithm. The former involves integrator sensitive to not only DC offset but also initial value [27], and bigger DC offset along with improper initial value easily leads to the saturation problem, which consequently results in the whole system being unstable. Nevertheless, the latter is able to avoid the troublesome problem. The currents involved in the latter can be calculated from measuring phase currents. Therefore this paper concentrates on the latter. Two kinds of current model flux estimators will be discussed in this paper, one being in $\alpha\beta$ -system (that means two-phase stationary coordinate)

and the other in dq-system (that means two-phase rotary coordinate). Obviously, two kinds of estimators used for healthy PMSM cannot be directly applied to unhealthy one. The modified flux estimators suitable for fault tolerant DTC are established as following.

3.1.1 Current model flux estimator in $\alpha\beta$ -system

In $\alpha\beta$ -system, the flux-linkages $\Psi_{s\alpha}$ and $\Psi_{s\beta}$, which is produced only by the stator current, can be expressed as following vector:

$$\begin{bmatrix} \Psi_{s\alpha} \\ \Psi_{s\beta} \end{bmatrix} = \begin{bmatrix} \frac{1}{2}(M-L) & \frac{1}{2}(M-L) \\ \frac{\sqrt{3}}{2}(L-M) & -\frac{\sqrt{3}}{2}(L-M) \end{bmatrix} \begin{bmatrix} i_b \\ i_c \end{bmatrix} \quad (7)$$

Since stator currents i_α and i_β in $\alpha\beta$ -system can be expressed as following vector:

$$\begin{bmatrix} i_\alpha \\ i_\beta \end{bmatrix} = \begin{bmatrix} -\frac{1}{3} & -\frac{1}{3} \\ \frac{\sqrt{3}}{3} & -\frac{\sqrt{3}}{3} \end{bmatrix} \begin{bmatrix} i_b \\ i_c \end{bmatrix} \quad (8)$$

Taking (8) into account, (7) can be rewritten as

$$\begin{bmatrix} \Psi_{s\alpha} \\ \Psi_{s\beta} \end{bmatrix} = \begin{bmatrix} L-M & 0 \\ 0 & L-M \end{bmatrix} \begin{bmatrix} i_\alpha \\ i_\beta \end{bmatrix} \quad (9)$$

Considering the rotor magnet, the stator flux-linkages Ψ_α and Ψ_β in $\alpha\beta$ -system can be expressed as following vector:

$$\begin{bmatrix} \Psi_\alpha \\ \Psi_\beta \end{bmatrix} = \begin{bmatrix} \Psi_{s\alpha} \\ \Psi_{s\beta} \end{bmatrix} + \begin{bmatrix} \frac{2}{3}\Psi_m \cos \theta_r \\ \frac{2}{3}\Psi_m \sin \theta_r \end{bmatrix} \quad (10)$$

The magnitude of stator flux linkage Ψ_s is

$$\Psi_s = \sqrt{\Psi_\alpha^2 + \Psi_\beta^2} \quad (11)$$

Electromagnetic torque estimator under two-phase operation in $\alpha\beta$ -system is given [17] as following,

$$T_e = \frac{3}{2}p(\Psi_\alpha i_\beta - \Psi_\beta i_\alpha) \quad (12)$$

where p is number of pole pairs.

Substituting (8) and (10) into (12), torque can be estimated.

3.1.2 Current model flux estimator in dq-system

In dq-system, the flux-linkage Ψ_d and Ψ_q can be expressed as following vector:

$$\begin{bmatrix} \Psi_d \\ \Psi_q \end{bmatrix} = \begin{bmatrix} L_d & 0 \\ 0 & L_q \end{bmatrix} \begin{bmatrix} i_d \\ i_q \end{bmatrix} + \begin{bmatrix} \Psi_m \\ 0 \end{bmatrix} \quad (13)$$

Where L_d and L_q are inductances in dq- system, i_d and i_q are currents in dq-system.

By Park and Clarke transformations, i_d and i_q can be yielded from phase current vector as follows

$$\begin{bmatrix} i_d \\ i_q \end{bmatrix} = \begin{bmatrix} \cos \theta_r & -\sin \theta_r \\ \sin \theta_r & \cos \theta_r \end{bmatrix} \begin{bmatrix} -1/2 & -1/2 \\ \sqrt{3}/2 & -\sqrt{3}/2 \end{bmatrix} \begin{bmatrix} i_b \\ i_c \end{bmatrix} \quad (14)$$

The magnitude of stator flux linkage Ψ_s is

$$\Psi_s = \sqrt{\Psi_d^2 + \Psi_q^2} \quad (15)$$

Electromagnetic torque developed in dq-system can be given as following

$$T_e = \frac{3}{2}p[\Psi_m i_q + (L_d - L_q)i_d i_q] \quad (16)$$

Substituting (14) into (16), torque can be estimated.

Here it is necessary to mention of how to obtain phase inductance L and phase mutual inductance M . Suppose mutual inductance M is one half of phase inductance L . Neglecting stator self-inductance's and mutual-inductance's second harmonics, we have,

$$L_d = L_q \approx L + M = L + \frac{1}{2}L = \frac{3}{2}L \quad (17)$$

Thus

$$L = \frac{2}{3}L_d \quad (18)$$

3.2 Switching table

The principle of designing switching table is to simultaneously reduce torque error ΔT_e and flux linkage error $\Delta \Psi_s$. So switching table to be adopted in this paper is the same as the case for DTC of healthy motor, which is shown as in Table 1.

Table 1 Switching Table

Estimator error		Sectors					
$\Delta \Psi_s$	ΔT_e	S1	S2	S3	S4	S5	S6
0	0	V5	V6	V1	V2	V3	V4
0	1	V3	V4	V5	V6	V1	V2
1	0	V6	V1	V2	V3	V4	V5
1	1	V2	V3	V4	V5	V6	V1

Sector S1- sector S6 in Table 1 are stator flux linkage positions as shown in Fig.5. Torque estimator error ΔT_e and flux linkage estimator error $\Delta \Psi_s$ are defined as following discrete functions,

$$\Delta T_e = \begin{cases} 1 & \text{if } T_e^* > T_e \\ 0 & \text{if } T_e > T_e^* \end{cases} \quad (19)$$

$$\Delta \Psi_s = \begin{cases} 1 & \text{if } \Psi_s^* > \Psi_s \\ 0 & \text{if } \Psi_s > \Psi_s^* \end{cases}$$

On the basis of the flux linkage estimator error $\Delta \Psi_s$ and torque estimator error ΔT_e , voltage vector V1-V6 offered by ELES inverter can be gotten via looking up Table 1. Fig.5 shows the symmetrical layout of six voltage vectors V1-V6 and six sectors S1-S6.

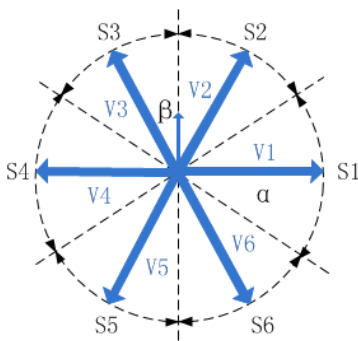

Fig.5 Layout of voltage vectors and sectors

3.3 PI controller and hysteresis controller

PI controller is used to regulate rotor speed. Its main advantage lies in accelerating the movement of the rotor speed towards setpoint and decreasing or eliminating the steady-state speed error. Two hysteresis controllers are adopted to adjust torque and stator flux linkage, respectively and define the switch control signals directly. If either estimated torque or flux deviates from the reference more than allowed tolerance, the transistors of ELES three phase inverter are turned off and on in such a way that the torque and flux errors will return in their tolerant bands as fast as possible. Properly selecting proportional & integral parameter, switch on & switch off point (the width of the tolerance bands) could keep the torque and phase current ripple small. These parameters are determined by differential evolution algorithm [28,29].

4 Simulation Results of Fault Tolerant DTC for PMSM with LOP or LOT

Table 2 Parameters of PMSM

Parameters	Values
Phase resistance	0.466Ω
dq-coordinate inductance	3.19Mh
Rotor magnetic flux	92.8mWeb
Number of pole pairs	1
DC bus voltage	70V
Rated speed	3000rpm
Rated torque	0.3Nm
Moment of inertia	0.0002Kg.m ³
Viscous friction coefficient	0
Coulomb friction torque	0

We take a PMSM as an example to validate the effective of proposed fault tolerant DTC, parameters of which are given in Table 2 [22]. According to two kinds of current flux estimators proposed, their corresponding systems of fault tolerant DTC for PMSM with LOP or LOT are established based on MATLAB/SIMULINK/SIMSCAPE platform.

The reference speed ω_r^* is set to 2000 rpm. The torque command T_e^* is set to 0.2Nm, which is the output of speed PI controller. The state flux linkage command Ψ_s^* is set to the value of the rotor magnetic flux. The simulation results are given from Fig. 6 to Fig.10 in terms of rotor speed, torque, stator flux linkages, stator currents, trajectory of stator flux linkage, etc.

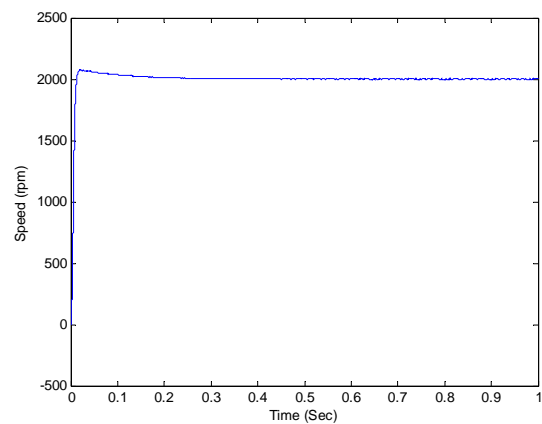

(a) Rotor speed response

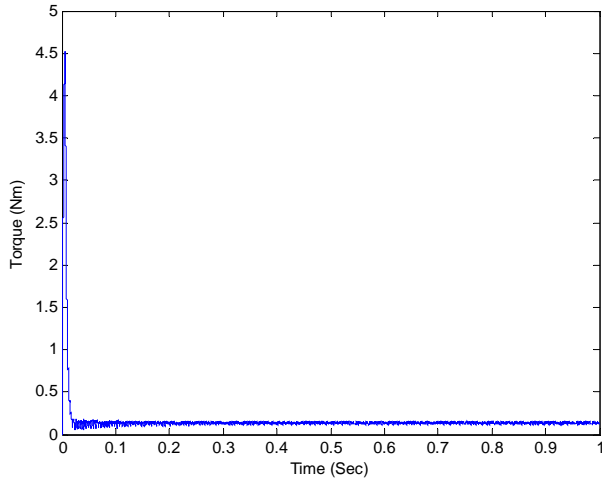

(b) Torque response

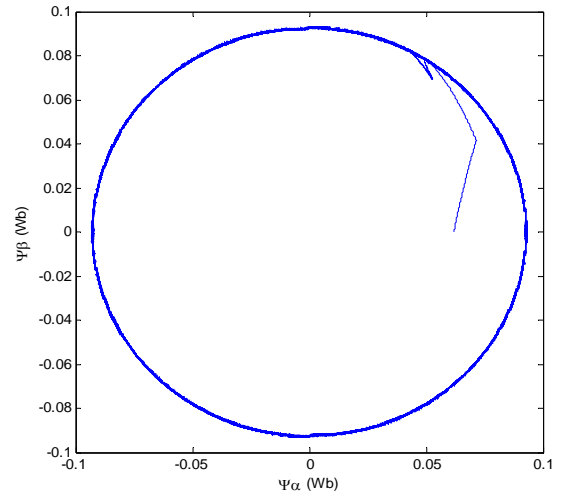

(e) Trajectory of stator flux linkage

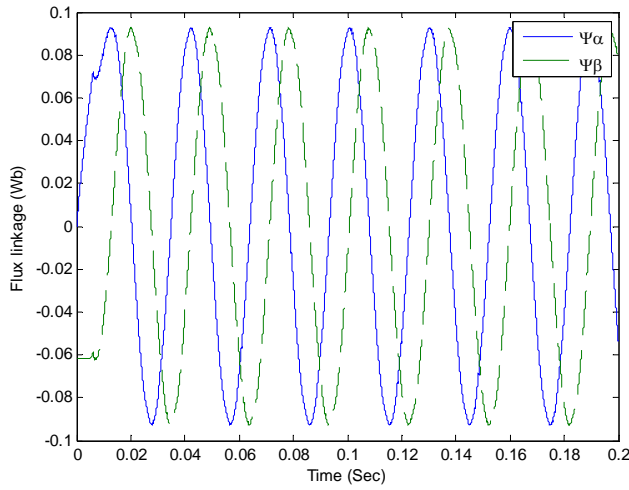

(c) Stator flux linkages Ψ_α, Ψ_β

Fig.6 Dynamic responses of DTC for healthy PMSM using estimator based-on $\alpha\beta$ -system

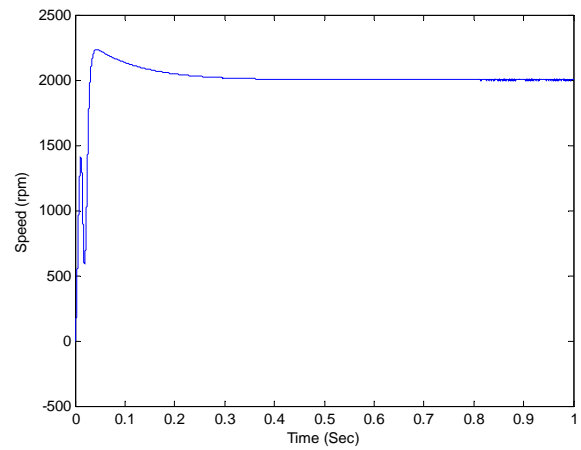

(a) Rotor speed response

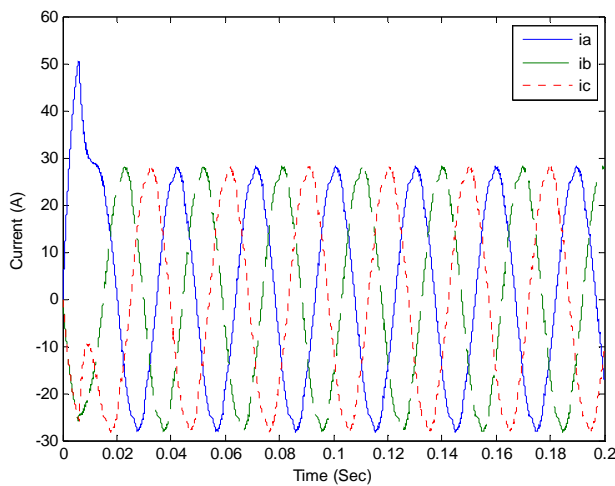

(d) Stator currents i_a, i_b and i_c

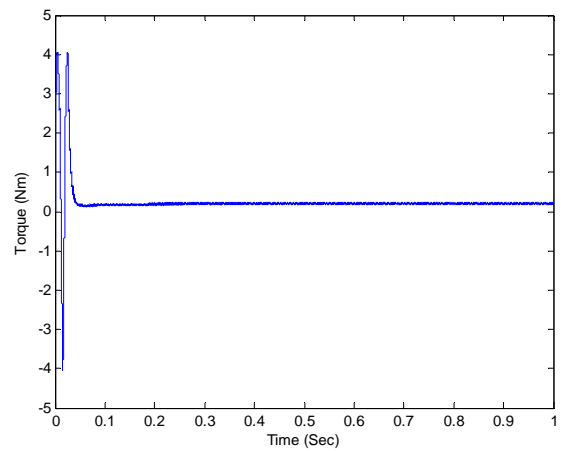

(b) Torque response

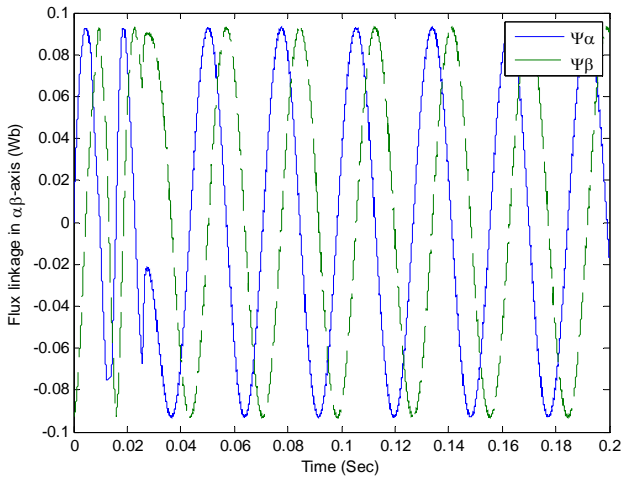

(c) Stator flux linkages Ψ_α, Ψ_β

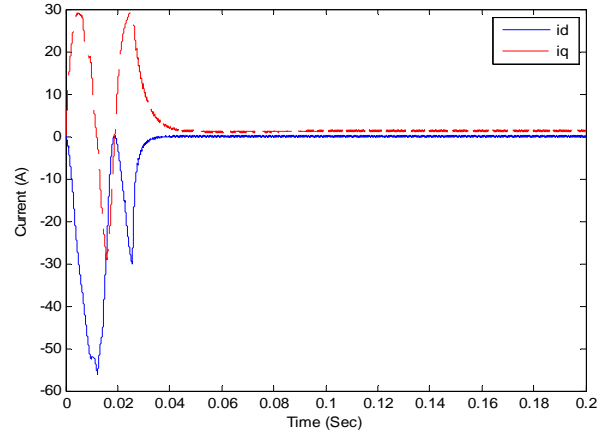

(f) Currents i_d and i_q

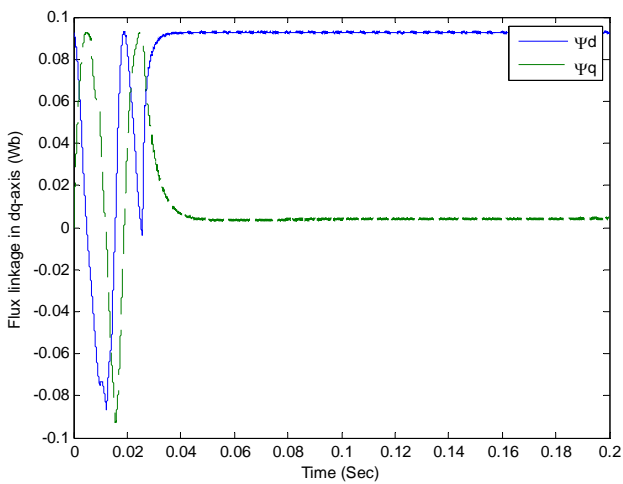

(d) Stator flux linkages Ψ_d, Ψ_q

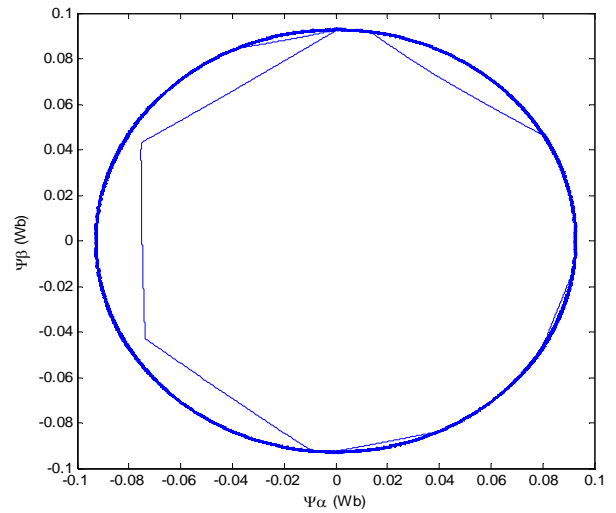

(g) Trajectory of stator flux linkage

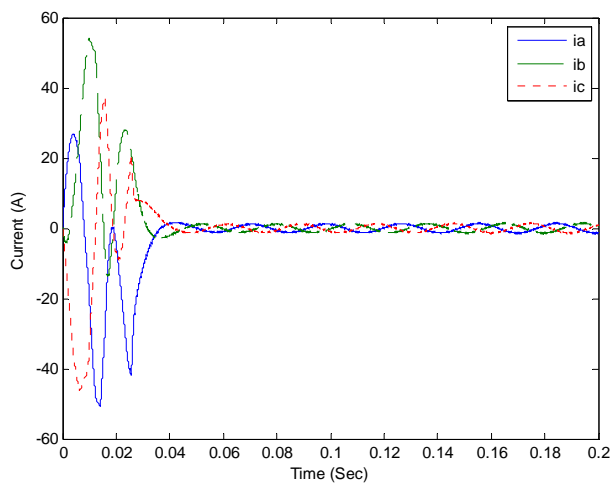

(e) Stator currents i_a, i_b and i_c

Fig. 7 Dynamic responses of DTC for healthy PMSM using estimator based-on dq- system

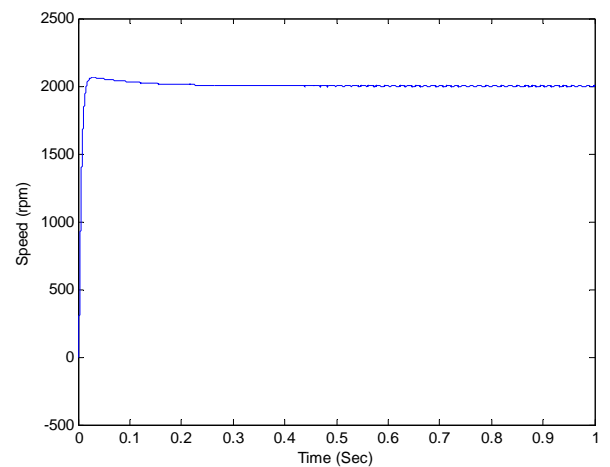

(a) Rotor speed response

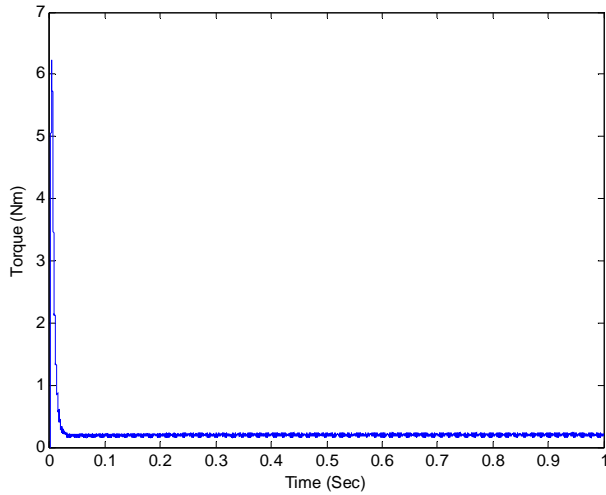

(b) Torque response

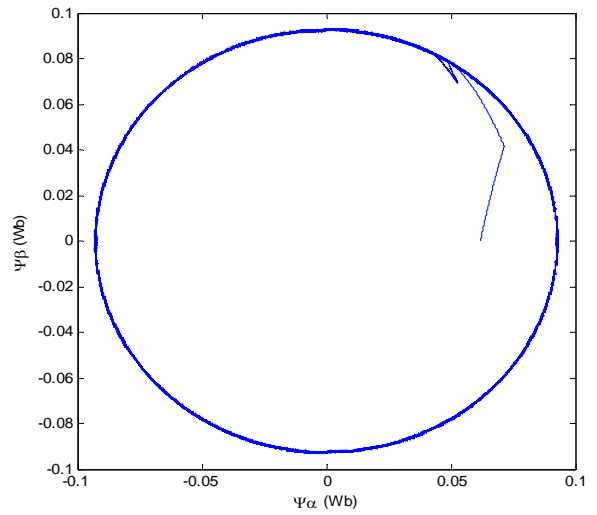

(e) Trajectory of stator flux linkage

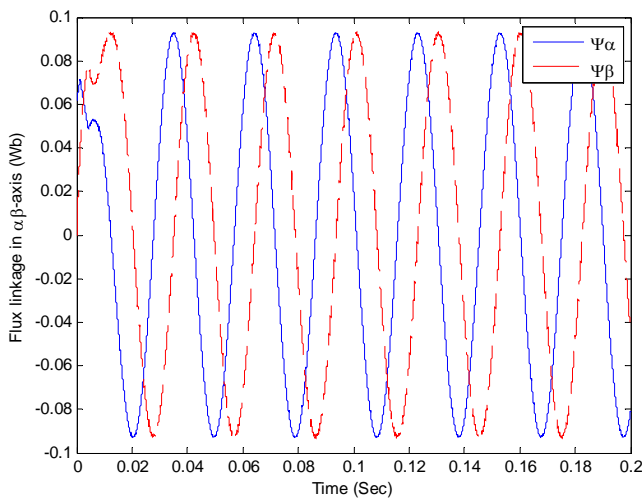

(c) Stator flux linkages Ψ_α, Ψ_β

Fig.8 Dynamic responses of fault tolerant DTC for unhealthy PMSM using estimator based-on $\alpha\beta$ -system

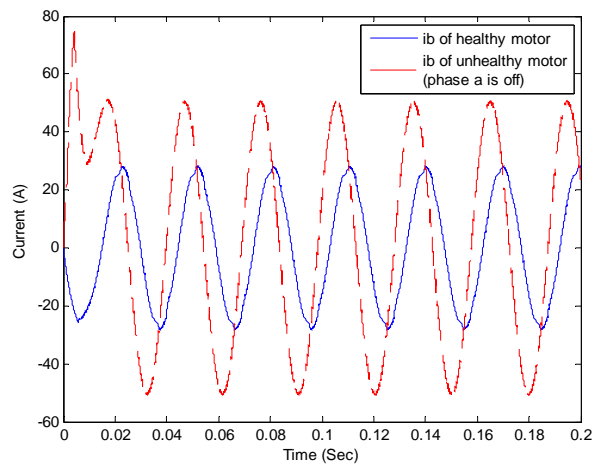

(a) Stator currents i_b of healthy and unhealthy motor

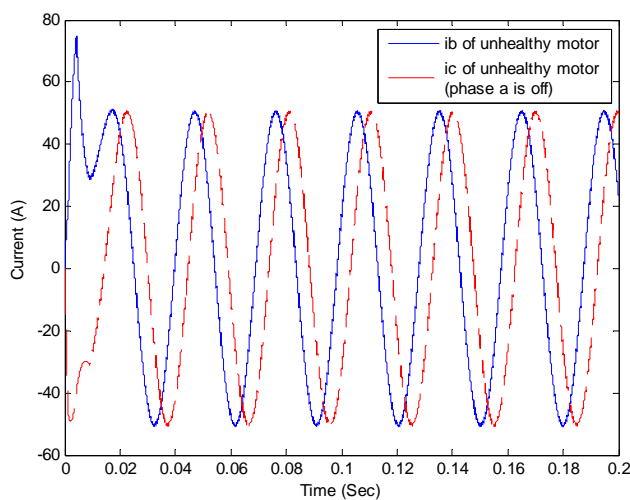

(d) Stator currents i_b and i_c

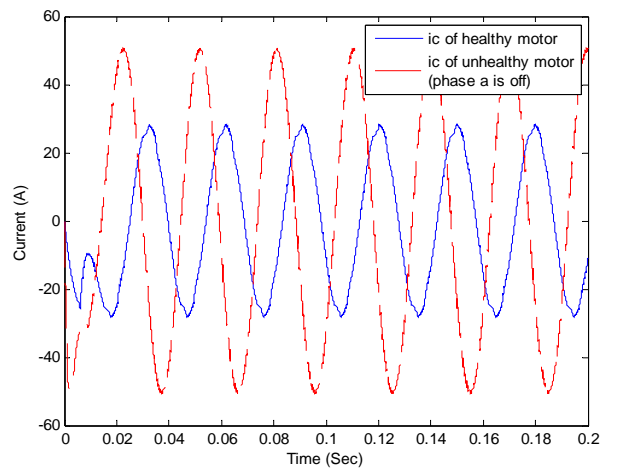

(b) Stator currents i_c of healthy and unhealthy motor

Fig.9 Phase currents comparison between healthy and unhealthy PMSM using estimator based-on $\alpha\beta$ -system

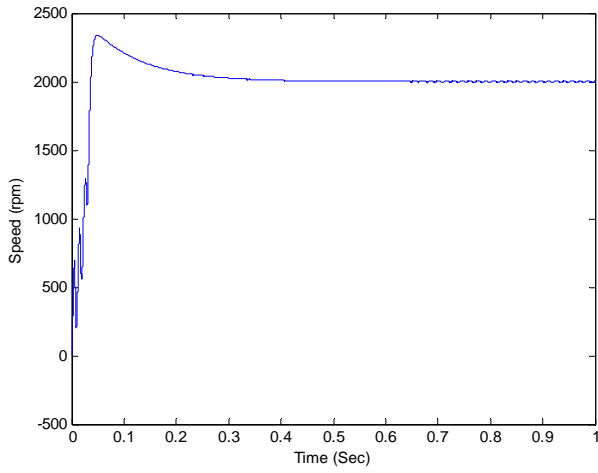

(a) Rotor speed response

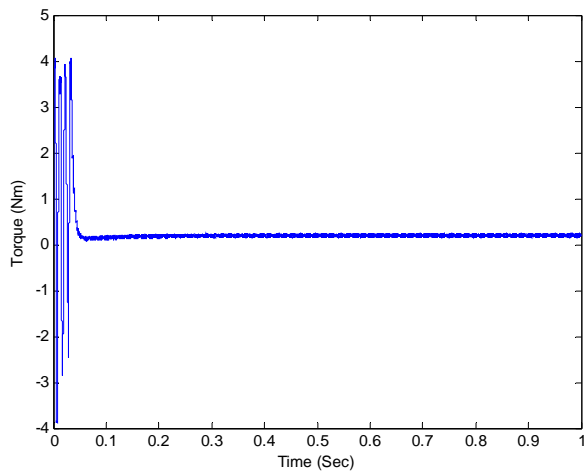

(b) Torque response

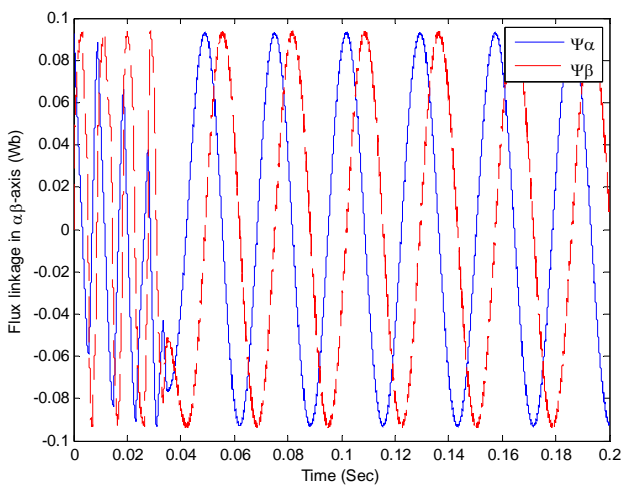

(c) Stator flux linkages Ψ_α, Ψ_β

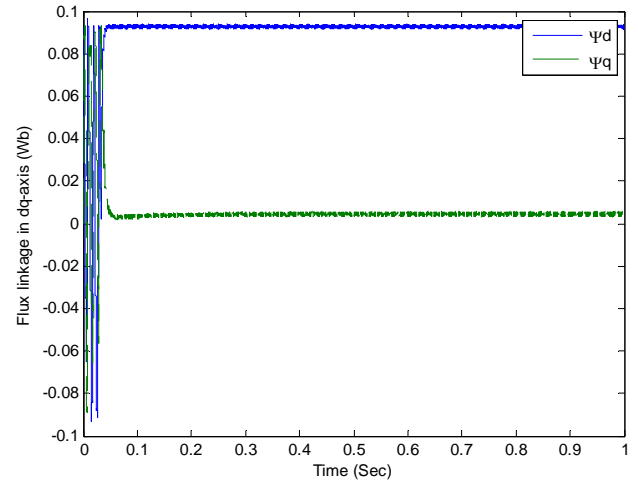

(d) Stator flux linkages Ψ_d, Ψ_q

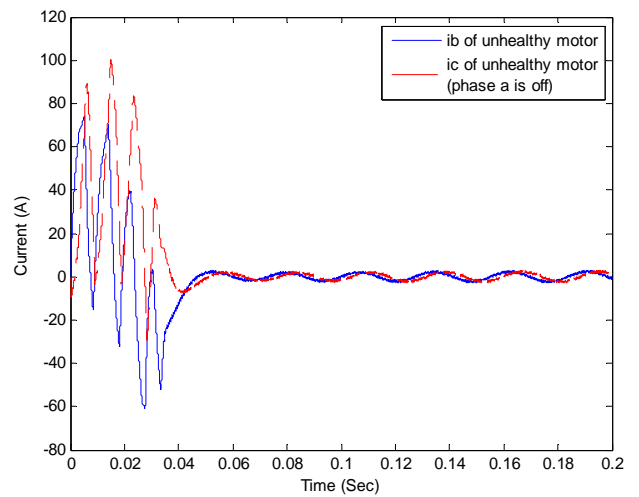

(e) Stator currents i_b and i_c

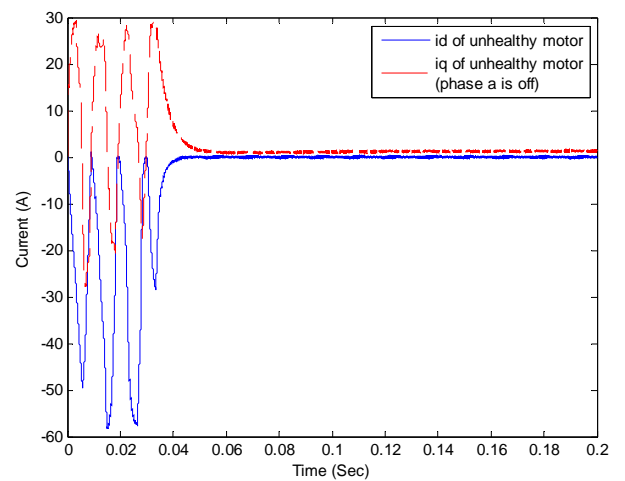

(f) Currents i_d and i_q

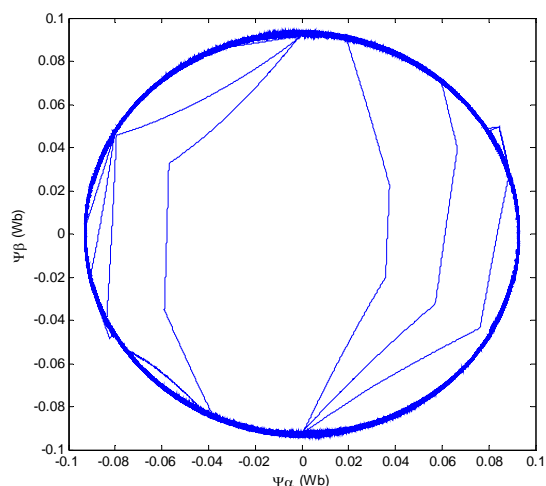

(g) Trajectory of stator flux linkage

Fig.10 Dynamic responses of fault tolerant DTC for unhealthy PMSM using estimator based-on dq -system

As for healthy PMSM, Figs. 6 and 7 are simulations of DTC using current model flux estimator based-on $\alpha\beta$ -system and dq -system, respectively. As for unhealthy PMSM with LOP or LOT DTC, Figs.8 and 10 are simulations of fault tolerant using current model flux estimator based-on $\alpha\beta$ -system and dq -system, respectively. And Fig. 9 shows the phase currents comparison between healthy and unhealthy PMSM using current model flux estimator based-on $\alpha\beta$ -system.

Analyzing above simulations, the following consequence could be obtained:

- Comparing Fig.6 with Fig.8 and comparing Fig.7 with Fig.10, it can be seen that the proposed fault tolerant DTC for PMSM has satisfactory performance regardless of whether current model flux estimator in $\alpha\beta$ -system or current model flux estimator in dq -system is employed.
- Fig.9 shows phase currents relationships between healthy and unhealthy motor. It can be clearly seen that phase b current could be approximately regulated to advance by 30° and phase c current regulated to be retarded by 30° . Meanwhile both phase b and phase c current magnitude is increased to be $\sqrt{3}$ times their previous value, which is consistent with the theoretical analysis [2].

- Fig.10 shows that the phase i_d and Ψ_q could be successfully modulated to be zero while i_q and Ψ_d to be constant. It means the fault tolerant DTC employing current model flux estimator in dq -system is equivalent to FOC.
- As far as dynamic response characteristic is concerned, by comparing Fig.6 with Fig.7 (for healthy PMSM) and comparing Fig.8 with Fig.10 (for unhealthy PMSM), it can be analyzed that the estimator based-on $\alpha\beta$ -system is better than one based-on dq -system in terms of rotor speed, torque, stator flux linkage and trajectory flux linkage, but the latter's phase currents required is smaller than the former's one. The results of comparison between estimators based-on $\alpha\beta$ -system and dq -system applies to both healthy and unhealthy PMSM.

To sum up, two kinds of proposed DTC strategies for PMSM with LOP or LOT can make electrical drive system to tolerate fault and therefore are effective and correct.

4 Conclusion

In this paper, model of three-phase PMSM with LOP or LOT is first built. Then its fault tolerant DTC is investigated based-on two current model flux estimators. The motor control system uses ELES inverter as power unit in the post-fault operation. The switching table adopted is the same as case of DTC for the healthy motor. The parameters of PI controller and hysteresis controller are determined by differential evolution algorithm. According to the above-mentioned two flux estimators, healthy and unhealthy PMSM DTC simulation systems are established individually and their performances are compared. The simulation shows that in the post-fault operation, on the one hand, two remaining phase currents can be approximately regulated to advance by 30° and retard 30° respectively and their magnitudes increased to be $\sqrt{3}$ times their previous value, on the other hand, the effect of fault tolerant DTC employing current model flux estimator in dq -system is equivalent to FOC. These results show that the proposed fault tolerant DTC yields satisfactory torque & speed control no matter what

any one of two flux estimators provided in the paper is employed, therefore is effective and correct.

References:

- [1] P. Potamianos, E. Mitronikas and A. Safacas, A Fault Tolerant Modulation Strategy for Matrix Converters, 5th IET International Conference on Power Electronics, Machines and Drives (PEMD 2010), 2010, pp.1-6.
- [2] T. H. Liu, J. R. Fu and T. A. Lipo, A Strategy for Improving Reliability of Field-Oriented Controlled Induction Motor Drives, *IEEE Transactions on Industry Applications*, Vol. 29, No. 5, 1993, pp.910-918.
- [3] S. Kwak and H.A.Toliyat, An Approach to Fault-Tolerant Three-Phase Matrix Converter Drives, *IEEE Transactions on Energy Conversion*, Vol. 22, No.4, 2007, pp.855-863.
- [4] SangshinKwak and TaehyungKim, Design of Matrix Converter Topology and Modulation Algorithms with Shorted and Opened Failure Tolerance, IEEE Power Electronics Specialists Conference(PESC 2008),2008, pp.1734-1740.
- [5] S.Khwan-on, L. de Lillo, L.Empringham, P.Wheeler, C.Gerada, N.M.Othman, O. Jasim and J.Claré, Fault Tolerant Power Converter Topologies for PMSM Drives in Aerospace Applications, 3rd European Conference on Power Electronics and Applications, 2009, pp.1-9.
- [6] S.Khwan-on, L.De Lillo, L.Empringham and P.W.Wheeler, A Fault Tolerant Matrix Converter Motor Drive Under Open Phase Faults, 5th IET International Conference on Power Electronics, Machines and Drives (PEMD 2010), 2010, pp.7-13.
- [7] S.Khwan-on, L.de Lillo, P.Wheeler and L.Empringham, Fault Tolerant Four-Leg Matrix Converter Drive Topologies for Aerospace Applications, 2010 IEEE International Symposium on Industrial Electronics , pp.2166-2171.
- [8] S. Bolognani, M. zordan and M. Zigliotfo, Experimental Fault Tolerant Control of PMSM Drive, *IEEE Transactions on Industrial Electronics*, Vol.47, No.5, 2000, pp. 1134-1141.
- [9] Jahns and M.Thomas, Improved Reliability in Solid-State AC Drives by Means of Multiple Independent Phase Drive Units, *IEEE Transactions on Industry Applications*, Vol.16, No.3, 1980, pp.321-331.
- [10] B.A.Welchko, T.A.Lipo, T.M.Jahns and S.E.Schulz, Fault Tolerant Three-Phase AC Motor Drive Topologies: A Comparison of Features, Cost, and Limitations, *IEEE Transactions on Power Electronics*, Vol.19, No.4, 2004, pp.1108-1116.
- [11] K.A.Corzine, S.D.Sudhoff and C.A. Whitcomb, Performance Characteristics of a Cascaded Two-Level Converter, *IEEE Transactions on Energy Conversion*, Vol.14, No.3, 1999, pp. 433-439.
- [12] R.L.A.Ribeiro, C.B.Jacobina,, E.R.C.da Silva and A.M.N.Lima, A Fault Tolerant Induction Motor Drive System by Using a Compensation Strategy on the PWM-VSI Topology, IEEE 32nd Annual Power Electronics Specialists Conference, Vol. 2, 2001, pp.1191-1196.
- [13] F.Genduso, R.Miceli and G.R. Galluzzo, Flexible Power Converters for the Fault Tolerant Operation of Micro-Grids, 2010 XIX International Conference on Electrical Machines (ICEM), 2010, pp.1-6.
- [14] Q.F.Teng and D. W. Fan, Robust H^∞ Reliable Control with Exponential Stabilization for Uncertain Delay Systems against Sensor Failure, *Electric Machines and Control*, Vol. 12, No.2, 2008, pp.195-201.
- [15] Q.F.Teng and D. W. Fan, Robust Fault-tolerant Control via State Observer for Uncertain Systems with Delay. *Dynamics of Continuous Discrete and Impulsive Systems--series B--Applications and Algorithms*, 2006, pp.382-386.
- [16] Q.F.Teng and D. W. Fan, Guaranteed Cost Reliable Control with Exponential Stabilization for Uncertain Time-varying Delayed Systems, *Systems Engineering and Electronics*, Vol.30,No. 3, 2008, pp.530-534.
- [17] C. Axenie, A New Approach in Mobile Robot Fault Tolerant Control, *WSEAS Transactions on Systems and Control*, Vol. 5, No. 4, 2010, pp. 205-216.
- [18] A.M.Yang, J.P.Wu, W.X.Zhang and X.H. Kan, Research on Asynchronous Motor Vector Control System Based on Rotor Parameters Time-varying, *WSEAS Transactions on Systems*, Vol. 7, No. 4, 2008, pp.384-393.
- [19] J. R. Fu and T. A. Lipo, Disturbance Free Operation of a Multiphase Current Regulated Motor Drive with an Opened Phase, IEEE Industry Applications Society(IAS) Annual Meeting, Vol. 1, 1993, pp.637-644.
- [20] M. B. R. Correa, C. B. Jacobina, E. R. C. Silva, and A. M. N. Lima, An Induction Motor Drive System With Improved Fault Tolerant, *IEEE Transactions on Industry Application*, Vol. 37, No.3, 2001, pp.873-979.
- [21] R. L. A. Ribeiro, C. B. Jacobina, A. M. N. Lima, and E. R. C. Silva, A Strategy for Improving Reliability of Motor Drive Systems

- Using a Four-Leg Three-Phase Converter, Applied Power Electronics Conference and Exposition(APEC 2001), Vol. 1, 2001, pp.385-391.
- [22] Z. Q. Zhu, K. Utaikaifa, K. Hoang, Y. Liu, and D. Howe, Direct Torque Control of Three-Phase PM Brushless AC Motor with One Phase Open Circuit Fault, IEEE International Electric Machines and Drives Conference (IEMDC 2009),2009, pp.1180-1187.
- [23] K.Utaikaifa, Performance Comparison of DTC of Open-Circuit Fault PM BLAC Motor Based on Modified Voltage and Current Model Flux Estimators, 2011 International Conference on Electric Information and Control Engineering(ICEICE), 2011, pp. 6369-6372.
- [24] T. Elch-her and J. P. Hautier, Remedial Strategy for Inverter-Induction Machine System Faults Using Two-Phase Operation, International Fifth European Conference on Power Electronics and Applications, Vol. 5,1993, pp. 151-156.
- [25] J. R. Fu and T. A. Lipo, A Strategy to Isolate the Switching Device Fault of a Current Regulated Motor Drive, Conference Record of the 1993 IEEE Industry Applications Society Annual Meeting, Vol. 2, 1993, pp.1015-1020.
- [26] F. Neri, Agent Based Modeling Under Partial and Full Knowledge Learning Settings to Simulate Financial Markets, *AI Communications*, Vol.25, No.4, 2012, pp. 295-305.
- [27] J. Hu and B. Wu, New Integration Algorithm for Estimating Motor Flux over a Wide Speed Range, 28th Annual IEEE Power Electronics Specialists Conference(PESC), Vol. 2, 1997, pp.1075-1081.
- [28] R. Storn and K. Price, Differential Evolution— a Simple and Efficient Heuristic for Global Optimization over Continuous Spaces, *Journal of Global Optimization*, Vol.11, 1997, pp.341-359.
- [29] R. Oonsivilai, A.Oonsivilai, Differential Evolution Application in Temperature Profile of Fermenting Process, *WSEAS Transactions on Systems*, Vol. 9, No. 6, 2010, pp.618-628.