

Recent Advances on Locomotion Mechanisms of Hybrid Mobile Robots

SHUN HOE LIM
UNIVERSITI MALAYSIA SABAH
Evolutionary Computing Laboratory
Faculty of Computing and Informatics
KOTA KINABALU, MALAYSIA
eohnuhs@outlook.com

JASON TEO
UNIVERSITI MALAYSIA SABAH
Evolutionary Computing Laboratory
Faculty of Computing and Informatics
KOTA KINABALU, MALAYSIA
jtwteo@ums.edu.my

Abstract: Many types of hybrid mobile robots that combine the characteristics of wheeled robot and legged robot have been developed in the past two decades. This paper is aimed at presenting a survey on various hybrid mobile robots based on their respective implemented locomotion mechanism. The survey is done on several recently developed hybrid mobile robots by inspecting the design concept of their locomotion mechanism. Besides that, this paper also discusses the factors that influence the design of a robust robotics platform which are important to consider when designing a robot. This work will be useful as a preliminary reference point for those who want to design a hybrid mobile robot.

Key-Words: hybrid mobile robots, robot locomotion, wheeled robots, autonomous robots

1 Introduction

Since the first implementation of mobile robots in World War II, mobile robotics has become an extremely popular research topic. By definition, a mobile robot is a machine with the capability to move in a given environment. In other words, mobile robots are able to move around in a specified environment and are not just fixed to one physical location. Mobile robot is a field of great interest in robotics as it has a close interaction with environment. Mobile robotics can be utilized in a wide range of applications. For example, service industry, military deployments, manufacturing, cleaning, entertainment and remote exploration, especially in search and rescue operations where human lives can be endangered.

For ground mobile robots' locomotion, wheels and legs are the two common adopted methodologies. From a biological perspective, land animals with their sturdy legs are able to move over uneven terrains smoothly and rapidly after a long evolution process. On the other hand, during pre-historic times, humans invented wheels that were specialized in rolling to assist on ground locomotion. The excellent performance of wheels in both power efficiency and traveling speed can scarcely be achieved by legged mechanism. A hybrid platform with the combination of leg and wheel has excellent maneuverability on flat ground and uneven terrain. Therefore, a hybrid platform is highly recommended for general indoor and outdoor environment operations as it is the trend for

"future" mobile platforms [1].

Mobile robots have been showing a great success in the real world implementation. For the first time, robots were assisting in an actual urban search and rescue mission of the World Trade Center tragedy on 11 September 2001. The team assisted by search and rescue robots had succeeded to discover more than 10 victims which are more than 2 percent of total victims discovered [2]. The successful involvement of mobile robots in real life rescue mission has garnered much attention from researchers.

In recent years, hybrid mobile robots have been designed for various functionality and purposes. For example, hybrid mobile robots designed for stairs climbing purposes, performing jumping behavior, in-situ reconfiguring robots posture and adapting to uneven terrain, among others. In general, hybrid mobile robots can carry out their mission better in rough terrain compared to traditional wheeled or legged mobile robots. Hybrid mobile robots utilize the advantages of both wheeled and legged mechanisms while compensating the downside of each other.

There are many successful examples of hybrid mobile robots which are built and designed for wide range of operations. A group of researchers from a few universities in Japan had developed a hybrid wheeled-legged platform through a retracting mechanism inspired by the armadillo [3]. The idea of a retractable wheeled-legged module is that the specially-designed wheels can be transformed into a legs-like

mechanism. PAW proposed by McGill University, is a four legs robot with wheels equipped at the end of each leg [4]. PAW is the first to combine wheeled mode locomotion with dynamically stable legged locomotion. University Lubeck in Germany developed WheeHy which is capable of doing in-situ reconfiguration of its posture [5]. One of the key features of WheeHy is that the robot can perform adaptation of its posture during its traversal over uneven terrain. National Taiwan University proposed a Quattropted platform with hybrid legged-wheeled locomotion. The proposed system utilizes a transformation method where the morphology of its wheels can be directly transformed into legs.

The aim of this work is to primarily inform the reader of the recent developments related to hybrid mobile robots from the review of numerous published papers in hybrid robots, and provide readers with some typical and promising mechanisms of hybrid mobile robot research. More and more research works are focused on hybrid mobile robots as their traversing capabilities in various rough environments. In section 2, we discuss the factors that influence the design of a robust robotics platform which are important to consider when designing a mobile robot platform. Various types of hybrid mobile robot mechanism are discussed in section 3 and the studies on previous works are discussed in detailed in section 4. In the last section, a conclusion is made as an overview of current hybrid mobile robot mechanisms and suggestions are proposed for future hybrid mobile robot design and development.

2 Factors That Influence The Design Of Robots

There are many factors that can contribute to the successful or failure of design, realization and functionality of a robotic platform. As seen from practice, it is very difficult to design a robot that can be functioning in multiple scenarios and terrains with different purposes. Commonly, robots are designed to perform specified tasks under certain environmental conditions. Therefore, robots can have different sizes and different locomotion mechanisms depending on the robots' missions respectively.

2.1 Factor - Size

When designing robots, designers may face difficulty to decide the size of robots where bigger or smaller robots have their own advantages and disadvantages. Bigger size robots can have more batteries, sensors and actuators that can be put onboard. More batteries

may on the first glance mean longer run-time of the robot as it can bring along back-up power supplies. However, bigger robots have a heavier weight if compared to smaller sized robots. Therefore, in order to move the heavy system, more electrical energy has to be supplied to the actuators/motors of the system.

Besides, bigger robots have the advantages to carry more processing elements/parts (i.e. embedded systems, sensors, and additional electronics) and more payload (i.e. aid materials during urban search and rescue mission) onboard. The robustness and functionality of the system can be enhanced by having more useful processing elements or parts. Due to the larger amount of sensors and actuators, the fault tolerance of the robot is also increased [5]. For example, if a sensor or actuator fails, the other sensors and actuators are still available, so the failure of some elements might not directly affect the performance of robot.

However, the bigger the system, the less agile and less maneuverable it is to go through some smaller and narrower paths. But for some rough terrains, depending on the locomotion mechanism implemented on the robot, the bigger they are, the easier it will be for the robot to overcome some bigger obstacles the robot, the bigger they are, the easier it will be for the robot to overcome some bigger obstacles [5]. Apart from this, there are robotic systems which are smaller in size. Smaller robots are preferable and suitable to carry out missions which have to go through smaller and narrower passages. However, the smaller the size of the legs/wheels or other traction elements by such robots may hinder the robots to easily overcome bigger obstacles and traverse in rough terrain.

Smaller robots have lighter weight as one of their advantages. This indicates the usage of actuators or any locomotion elements that consume less electric energy as opposed to the bigger robots. Although with the drawback of fewer batteries on board, smaller robots may probably overcome this with lower energy consuming actuators. However, fewer sensors on smaller robots may indicate lower levels of redundancy as well as the system might provide data collected in lower quality or with limited resolution. This is because the quality of data will be influenced by the size and number of sensors integrated on the robot. In conjunction with these drawbacks of smaller sized robots, these robots can be utilized to build robot swarms. Swam robotics is an approach to the coordination of multi robot systems where a large numbers of small physical robots are grouped to perform certain tasks. The robots in this way may still fulfil the mission provided that they will cooperate together and interchange acquired sensor data. The failure of some robots may not directly affect the outcome of missions.

Lastly, smaller robots are usually less costly than the bigger robot systems and therefore this is one more argument that can be considered for building up robot swarms to carry out some mission tasks [5].

2.2 Factor - Locomotion Mechanisms

Another factor when designing a robot is that appropriate locomotion mechanisms should be chosen according to the operating environment of the robot. Locomotion design in mobile robots can traditionally be divided into two methods: wheeled (tracked mechanisms can be included in this category) and legged.

Wheeled robots have the characteristic that they can traverse a longer distance with a faster speed with their wheels than legged robots. Besides that, wheeled robots are more powerful in terms of load/weight ratio [6]. This may be due to the current state of actuation technology where rotary actuation is more energy efficient and robust than the current state of linear and hydraulic actuation technology when comparing the distance traversed with such actuators [5]. Additionally, it is easier and less complex when designing the controller of a wheeled robot. By having those advantages, it directly benefits the development cost of a wheeled robot whereby it is cheaper than building a legged robot. However, there are limitations for wheeled robots as wheeled robots generally having difficulties when traversing over a rough terrain i.e. with obstacles, steps, discontinuous contact surface, among others.

On the other hand, when looking into nature, animals with legs are capable to perform multiple behaviors i.e. walking, running, and jumping over different variety of terrains. This has been the inspiration for researchers to develop legged robots in pursuing the excellent locomotion behaviors. In general, legged robots provide a flexible adaptive mobility in unstructured environment and a better performance while traversing over rough terrain. Although there are ongoing researches on developing or studying legged robots, the state of the art of nowadays for legged locomotion mechanism are still less efficient than the natural "way" of leg motion seen from animals [5].

There are some techniques nowadays which try to mimic some locomotion processes seen in nature and develop more efficient locomotion systems, but it can be still concluded that current legged robots nowadays are less energy efficient than the wheeled robots [5]. However, legged robots are still having better mobility in rough terrain since they can use isolated footholds that optimize support and traction, whereas wheels require a continuous path of support [7].

Since there are advantages for both wheeled and

legged locomotion mechanisms, here it raises the idea of combining the advantages of each other into a single platform: hybrid mobile robots. In general, hybrid mobile robots are integrated with both legs and wheels. There are few types of hybrid mechanisms that have been developed and the mechanisms are discussed in detailed in the next section, section 3.

3 Hybrid Mobile Robot Locomotion Mechanisms

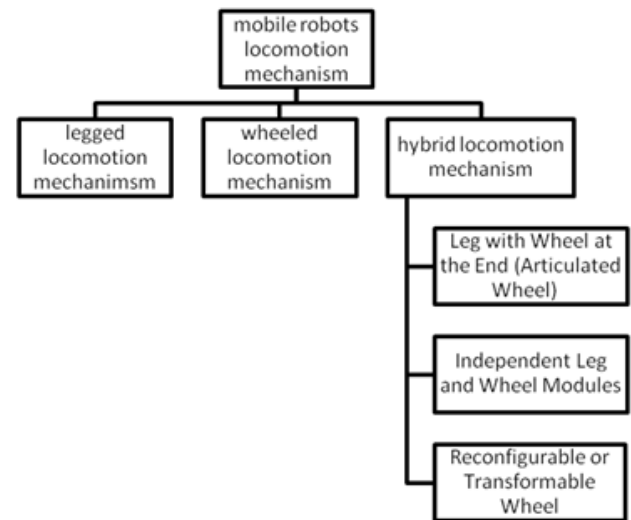

Fig. 1: Mobile Robots Locomotion Mechanism Categorization

Fig.1 shows the overall summary of mobile robots locomotion mechanism classification. As hybrid mobile robots are employing the merits of both traditional wheeled and legged locomotion mechanisms, hybrid locomotion mechanism seems to be the trend in designing mobile robots. Thus, various hybrid locomotion mechanisms have been invented and developed over the last decade. Basically, hybrid wheel-leg locomotion mechanisms can be categorized into three categories as shown in Fig.2. From the figure: (a) legged mechanism attached with a wheel at its foot end or known as articulated-wheeled, (b) independent wheel and leg modules on the body of the mobile robot, and (c) reconfigurable or transformable wheel modules which can be transformed into leg modules and vice versa.

3.1 Leg with Wheel at the End (Articulated-Wheel) Hybrid Locomotion Mechanism

With wheels attached at the end of each legs, this kind of hybrid mechanism helps a traditional leg robot

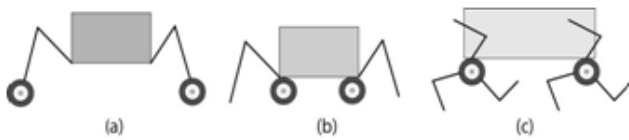

Fig. 2: Categories of Hybrid Wheel-Leg Robot (Used with permission from [3])

to overcome their complex and slow walking mechanism. On the other hand, the articulated wheels allow the hybrid mobile robot to traverse through uneven and also discontinuous contact point terrain where a traditional wheeled robot might have difficulty to go through. Besides that, there are researchers who have been making use of this mechanism to build robots with bounding gaits.

Basically, a hybrid mobile robot with this locomotion mechanism may have two switchable modes of locomotion which are wheeled mode and legged mode. However, different sizes of wheels give merit and demerit to each mode [3]. When it is on wheeled mode, bigger wheels are preferable than small wheels as bigger wheels allow the hybrid mobile robot to climb or traverse over a single step. However in legged mode, smaller wheels are better than big wheels. Due to its small footprint, the hybrid robot can choose a good contact spot of the foot on uneven terrain with gaps [3].

There are a lot of hybrid mobile robots that have been built with this kind of hybrid locomotion mechanism. For example, Roller Walker [8] which has legs with passive wheel at the end enables it to switch between leg locomotion and a roller skating motion. A novel leg-wheel hybrid stair-climbing vehicle "Zero Carrier" [9], which consists of eight unified prismatic-joint legs, four of which attached with active wheels and other four attached with passive casters. Hylos [10] utilizes active suspension-leg mechanism with its four wheels providing it the ability to reconfigure its posture when traversing through rough terrain. A bounding gait robot PAW [4] also employs active wheels at the distal end of each leg.

3.2 Independent Leg and Wheel Modules Hybrid Locomotion Mechanism

This hybrid locomotion mechanism can be classified as wheeled mechanism with the assistance of leg modules or in the opposite way which is a legged mechanism with the assistance of wheel modules. Basically, for wheeled mechanism with the assistance of leg modules hybrid locomotion mechanism, the robot traverses with wheel modules while making use of leg

modules to increase the maneuverability of the robot in rough terrain. With leg modules embedded, a traditional wheeled robot may have the ability to climb or pass over obstacles.

For legged mechanism with the assistance of wheel modules hybrid locomotion mechanism, the robot moves by its leg modules with the support of passive wheels for stability purposes. Static and dynamic stability is provided by the set of wheels, while locomotion is still mainly dependent on the legs' motion. By replacing some legs of an ordinary legged robot into passive wheels, the new hybrid mobile robot can exploit the advantages of both legged and wheeled robot. With the passive wheels, the robot can move faster and carry more weight with a simpler controller [6]. At the same time, the motion of the legs provides the ability for climbing/overcoming obstacles and better maneuverability in rough terrain.

For example, Chariot III [11], a leg-wheel robot with four legs and two independent wheels. There are two operation modes for Chariot III which are wheeled mode and leg-wheeled mode. The hybrid locomotion of Chariot III is designed for moving on unexplored rough terrains. Wheelleg [12] is a wheel-legged robot which has two individual rear wheels and two front legs with three degrees-of-freedom. A bio-inspired hybrid leg-wheel robot built by King Mongkut's Institute of Technology North Bangkok [13] also implemented two front legs and two rear wheels design. The biological principle of swinging two front legs alternatively during the walking of insects was the inspiration for the robot's design. The robot movement is propelled by the two front legs pushing the wheels to go forward and backward.

3.3 Reconfigurable or Transformable Wheel Hybrid Locomotion Mechanism

Distinct from both previous hybrid locomotion mechanisms which have separate wheels and legs mechanisms, this mechanism of hybrid locomotion utilizes transformable or reconfigurable wheels. The transformable wheels can change into legs when leg locomotion is preferable for example traversing in rough terrain.

For example, a hybrid legged-wheeled platform Quattroped was introduced by National Taiwan University. The robot implements a transformation method where the wheels of the robot can be directly transformed into 2 degree-of-freedom legs. An armadillo-inspired wheel-leg robot was proposed by Osaka University. Each wheel of the robot was built with joints and can be turned into a leg by bending the joints in a reversed direction [3].

4 Study On Recent Developed Hybrid Wheel-Leg Mobile Robots

The idea of hybrid wheel-leg locomotion has been proposed several decades ago when researchers were trying to compensate the pros and cons of wheeled and legged locomotion. Thus, there are numerous hybrid wheel-leg mobile robots that have been developed and built up to today. However, in this section, we are presenting the discussion on the latest hybrid wheel-leg mobile robots which had been developed in last few years. The discussion will be categorized according to the hybrid locomotion mechanism classification.

4.1 Leg with Wheel at the End (Articulated-Wheel) Hybrid Locomotion Mechanism

4.1.1 Bounding Gait in a Hybrid Wheel-Leg Robot

The PAW (Platform for Ambulating Wheels) robot, an articulated suspension system, implements the leg with a wheel at the end hybrid locomotion mechanism. PAW was developed by Centre of Intelligent Machines from McGill University with the support of Autonomous Intelligent Systems Section Defense R&D Canada [4] [14].



Fig. 3: The PAW robot with bounding gait (Used with permission from [14])

PAW as shown in Fig.3, is a four-legged robot where each of its leg is attached with wheel. PAW uses SCOUT II's frame but with a terser and lighter version. However, each leg of PAW is equipped with an active wheel instead of a passive wheel. The primary operation mode of PAW is wheeled mode. In this mode, all the wheels of the robot can be repositioned by the four hip motors. While in legged mode, each wheel is actively locked, allowing PAW to perform dynamic behaviors such as bounding and jumping. By equipping legs with repositionable wheels,

PAW is able to perform more advantageous turning, braking and bounding movements.

PAW implements an altered edition of the standard differential steering method to drive the turning of the robot. The traditional differential steering method is driven by changing the speed of one side of the wheel of the robot while the position of legs is fixed whereas PAW changes the position of its wheels by moving its legs to lower shear forces on them. By bringing the inner legs of the turn closer while keeping both of the outer legs upright, the centre of mass of the robot will be lower and thus lean the robot into the turn.

Besides turning, PAW is able to brake or perform stopping without pitching over. Braking in a sudden or inappropriate legs angle can result in pitching motion. The legs of PAW are places in a sprawled posture during forward and reverse driving, which is about plus or minus 11.5 degrees with regard to the robot body's vertical reference. During braking, the kinetic energy of the robot can be dissipated by motors using low gain PID controllers.

For the bounding gait of PAW, two separate state machines are used to drive the gait where one for the pair of rear leg and the other one for the front. The bounding behavior of PAW starts from a standing position and continues with a merging of open loop lean back and kicking movements. There are three phases for a single bounding behavior, which are the flight phase, stance retraction phase and stance break phase which can be seen in Fig.4.

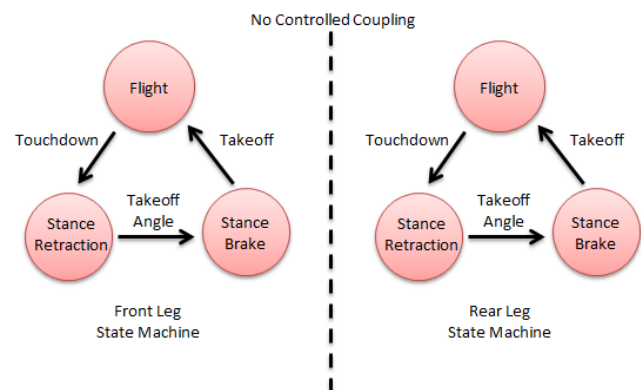

Fig. 4: Phases in rear and front legs' bounding state machines

During the flight phase, a position-based PID controller is used to control the legs of the robot in order to obtain the desired touchdown angle. A constant desired stance torque is used during the stance retraction phase, in order to reposition the robot into takeoff angle. After reaching the takeoff angle, stance brake phase will take place. The bounding state machine

takes care of the switching procedure between these modes.

4.1.2 Reconfiguration and Obstacle Negotiation Methods on Hybrid Leg-Wheeled Robot

Graduate University of Chinese Academy of Sciences in cooperation with State Key Laboratory of Robotic Shenyang proposed a reconfiguration control method for a hybrid leg-wheeled robot [16]. They used a six leg-wheeled robot as their platform. 12 individual motors are used to drive the six legs and six wheels independently. Passive suspensions are installed at each of the legs, which will later be used as an information collector of contact state between wheels and terrain. Besides reconfiguration method, they also exerted the obstacle negotiation ability to the leg-wheeled robot.

Their proposed reconfiguration method consists of three stages. Firstly, according to the power exerted on legs, the touching status of the wheel on the terrain can be estimated. After that, information about the current configuration of the robot is gathered in order to compute the expected leg angles. Lastly, the legs are adjusted according to the angles calculated in second stage to obtain the expected configuration.

The most important feature that differentiates a hybrid legged-wheeled robot from a traditional wheeled robot is its ability to negotiate obstacles [16]. The proposed obstacle negotiation ability can mainly handle standard obstacles, such as ridges and ditches. By using laser range finder with obstacle detecting algorithm, the robot can determine its ability to stride over the approaching obstacle. The robot will then regulate the heading to locate an appropriate striding direction if the obstacle can be stridden. Otherwise, the robot will activate an obstacle avoidance strategy to bypass the obstacle. As crossing ditches and ridges requires an association of moving upward and downward procedures, two control strategies have been proposed in order to enable it to climb with an upward step and a downward step.

Climbing an Upward-Step

The robot will measure the gradient of the slope whenever the robot approaches an upward-step. The robot will climb on it directly by implementing the reconfiguration method if the robot can pass through the step (small gradient). Otherwise, the robot will use the control strategy as in Fig.5 to climb over it.

Firstly, the robot will reconfigure itself according to the height of the upward step as shown in Fig. 5.1. With the support of an odometer, the robot will move forward in order to put the front wheel on top of the step. After the front wheel is put on top of the step,

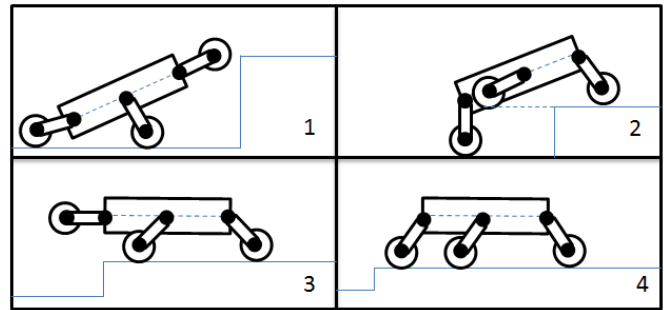

Fig. 5: Reconfiguration methods for climbing the upward step

the angles of the front legs and rear legs are adjusted as in Fig. 5.2. The robot will move forward again to place the middle wheel on top of the step. After that, the rear leg will be pulled onto the step then only the robot will be recovered back to the original robot configuration.

Climbing an Downward-Step

Similar with the climbing upward step strategy, the robot will measure the gradient of the slope when a downward-step is approached. The robot will go down the step directly if the gradient is small enough. Otherwise, the control strategy as in Figure 6 will be implemented to climb down from the step.

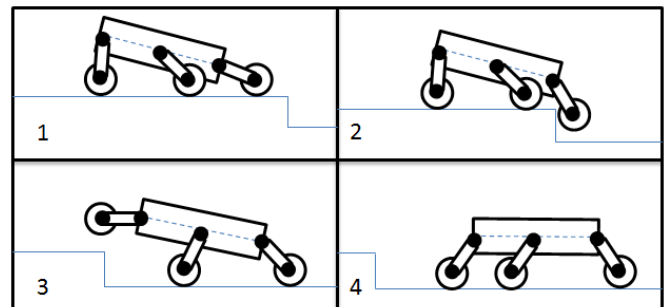

Fig. 6: Reconfiguration methods for climbing the downward step

Firstly, the robot will be reconfigured as in Fig. 6.1 and move forward. The robot will move forward until the front wheel goes off from the step. In order to identify whether the front wheel is out from the step, the velocity of the moving robot and the revolution rate of the front wheel will be inspected while the robot is moving forward. This can be inferred where the moving speed of the robot is much smaller than the revolution rate of the front wheel. When the front wheel is found going off from the step, the robot will move forward with the assistance of the odometer.

The robot will then stop after marching a certain distance. After that, the angle of the front leg is adjusted. With the similar method that has been described previously, the robot will advance forward along with the inspection on whether the middle wheel is going off from the step. When the middle wheel is found going off from the step, the robot is reconfigured as in Fig. 6.3. Finally, the robot will move forward while putting down the rear wheel onto the floor and the robot is recovered to the original marching configuration.

4.1.3 In-situ Reconfigurable Hybrid Wheeled-Legged robot - WheeHy

The Institute of Computer Engineering from University Lubeck Germany proposed the design of a wheeled-legged hybrid robot platform named WheeHy [5]. WheeHy robot is entitled of adapting its posture to uneven terrain which it is traversing over and performing in-situ reconfiguration of its posture.

The design of WheeHy is different from common hybrid wheeled-legged robot where it is a three legged wheel-legged robot instead of quadruped robot which can be seen in Fig.7. The purpose of having a three legged robot design is to lower the weight of the robot in comparison to the quadruped robot, and in the same time the stability and maneuverability are not drastically decreased.

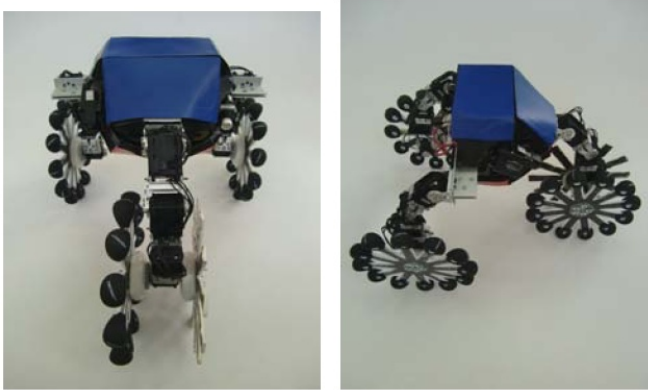

Fig. 7: Front view and side view of WheeHy (Used with permission from [5])

WheeHy was designed with "star" like wheels in order to lower its weight and at the same time to have enough supporting elements to cope with the weight of the robot and dynamics introduced when traversing over different terrains. Rubber elements are integrated at the end of each part of the "star" like wheels for a better grip on different kinds of surfaces. However, there are wheel "adapters" on each of the robot legs, this enable the wheels of the robot to be replaced with some other type of wheels if required.

The robot's control architecture provides several interfaces which including the control for the legs and wheels; balancing of the robot over uneven terrain; check for the need and perform reconfiguration and data logging. There is a network interface provided, thus WheeHy can be remotely controlled. Fig.8 shows the control architecture of WheeHy.

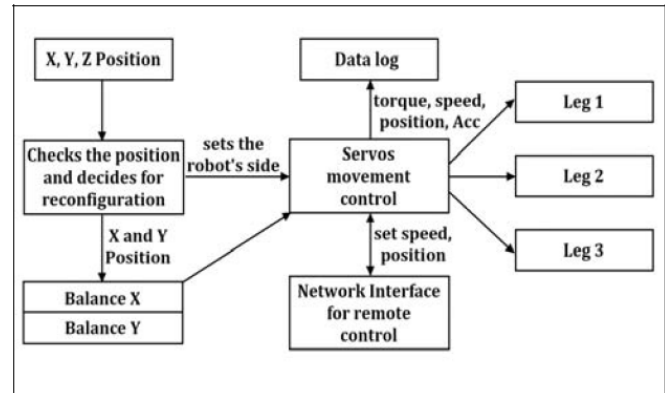

Fig. 8: Control architecture of robot WheeHy (Used with permission from [5])

For a balancing strategy over an uneven terrain, inclination sensors are used to obtain the interaction information of wheels and surface. Depending on the values read from the inclination sensors, the robot legs will change in upward or downward direction in order to adapt to the terrain conditions and maintain a parallel position of the robot body with respect to the terrain. This balancing capability of the robot allows crossing over an uneven terrain with more stability and therefore lowering the risk of tipping over in uneven terrain.

Although the balancing capability of the robot allows it to mitigate potential tip over situations, the robot is still enhanced with a new feature which is the reconfiguration capability. When the robot is tipping over, it can realize the tilt position with the provided onboard accelerometer sensors that it has tumbled over. The robot can recognize that it has tipped over by reading the current values and comparing them with the "normal" body position accelerometer values which are known in advance. Then the reconfiguration strategy is activated by stopping the movement of the robot wheels at first. After that, the legs of the robot are stretched out in parallel to its body position and moved down on the appropriate side of the body. In that manner, WheeHy is able to stand up again and continue with its mission.

4.2 Independent Leg and Wheel Modules Hybrid Locomotion Mechanism

4.2.1 A Bio-Inspired Hybrid Legged-Wheeled Mobile Robot

A bio-inspired hybrid legged-wheeled mobile robot has been developed by the Mechanical Engineering Department of King Mongkut's Institute of Technology North Bangkok [13]. They used the biologically inspired kinematics of insect's legs as the leg design of the hybrid leg-wheel robot. They utilized one of the key features from the construction of insect leg which is the multi-segmented nature where segment joints consist of single or multiple degrees of freedom. Thus, the robot in their work implemented the biological principles of swinging the two front legs alternatively during the walking of insect as the inspiration for the robot design.

The robot has two front legs that are functioning similarly with insect legs. However, the robot legs are kinematically simpler than the insect in order to simplify the mechanical design. Both legs of the robot were designed with two degrees of freedom. With this leg design, the robot will have the capability to navigate over rough terrains and move over large obstacles with a faster speed and less energy. There are two passive wheels attached at the back of the robot. Thus, the robot movement is propelled by the two front legs that pushed the wheels to go forward and backward. Fig.9 shows the model of the robot.

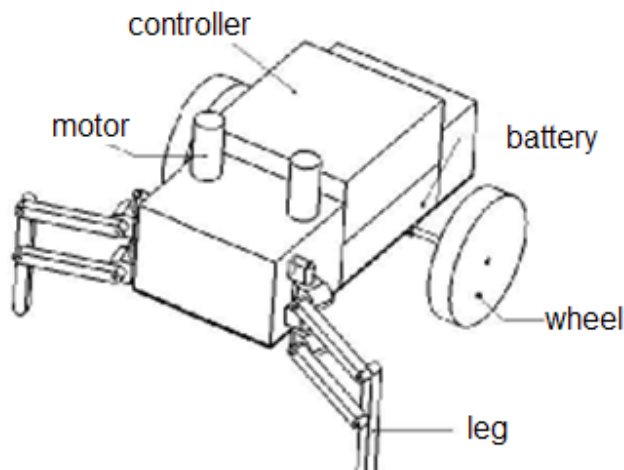

Fig. 9: Model of Bio-Inspired Hybrid Leg-Wheel Robot (Used with permission from [13])

Fig.10 and Fig.11 show the movement of the two front legs of the robot. The leg can move in a total of 90 degrees from the top view angle as well as from the front view angle.

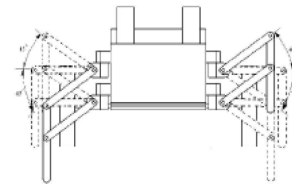

Fig. 10: Front View of Leg Movement of Bio-Inspired Hybrid Leg-Wheel Robot (Used with permission from [13])

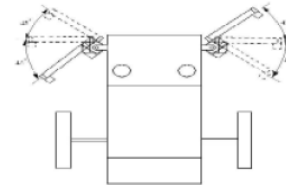

Fig. 11: Top View of Leg Movement of Bio-Inspired Hybrid Leg-Wheel Robot (Used with permission from [13])

The controller developed for the hybrid leg-wheel robot front legs was based on common feed-forward design. The controller is programmed on a basic Stampbox microcontroller by Parallax. There are total four motors are embedded in the robot where two motors on each leg. Since the wheels movement is ran by the driving force of the two front legs, no motor is required for wheels. The Stampbox will take the feedback signals from the four joint sensors which are potentiometers and also from foot sensors to determine the foot state whether is on or off the ground. Then the Stampbox will send either a clockwise rotation or counterclockwise rotation signal to motors.

4.2.2 A Two Legs and Two Independent Wheels Hybrid Robot, Wheeleg

In the DEES Robotic Laboratory of University of Catania, the practical design of the robot Wheeleg was realized and built [12]. Wheeleg is a robot with two individual rear wheels and two front legs. The two cylindrical type front legs of the robot are pneumatically actuated with three degrees-of-freedom. While the two back wheels of the robot are individually driven by two motors. Fig.12 shows the hybrid robot, Wheeleg.

With the design of the rear wheels, mostly all of the robot weight is supported by the rear wheels. While the front legs are designed for improving grip purposes which also enable Wheeleg to overcome obstacles. The design of Wheeleg robot allows it to have an improved maneuverability on rough terrain, if com-

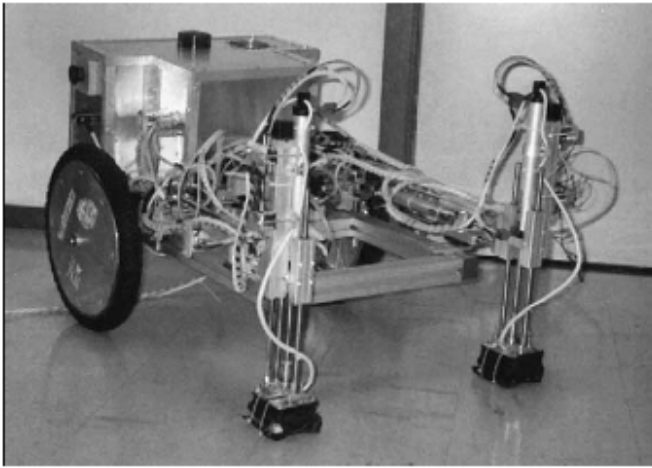

Fig. 12: The hybrid robot, Wheeleg (Used with permission from [12])

paring to an ordinary wheeled mobile robot. At the same time the movement of Wheeleg is also faster, more stable and easier to control than an ordinary four legs mobile robot.

The design of Wheeleg acts as a beneficial solution for operation in a simpler environment where legged mobile robots are not required, but at the same time a better surface gripping is preferable. However, according to the developer, there are drawbacks from the design of Wheeleg. For example, insufficient pressure on legs causing traction difficulty, the constraint on static and dynamic stability when traversing over rough terrain, and a more complicated control system is needed in order to drive the wheels and legs simultaneously.

Wheeleg robot has a total of eight microcontrollers, six for controlling the pistons and the other two for the set of wheels. The overall control supervising and user interfacing is done by a microprocessor. There are four digital valves in totals which are joined with each pneumatic cylinder of both of the legs where two valves are for air inlet and the other two are for outlet. Pulse width modulation (PWM) signal is used to control the digital valves which can be generated by controllers. There is a touch sensor mounted on each foot in order to determine which foot is on the surface of terrain. A linear potentiometer is mounted on each joint of the leg in order to give feedback signal of the leg position to the pneumatic controller.

While for the wheels, each wheel is actuated by a standard brush DC motors with gear reducers. Low cost standard brush DC motors were purposely chosen in order to decrease the system cost. Each motor is controlled by a different controller respectively which is coded with the position feedback encoder. Besides

that, the controller is also connected to the master processor for exchanging commands purposes.

4.3 Reconfigurable or Transformable Wheel Hybrid Locomotion Mechanism

4.3.1 A Leg-Wheel Hybrid Mobile Platform with Transformable Wheel Morphologies

A four legged legged-wheeled hybrid platform was proposed by the Department of Mechanical Engineering from National Taiwan University [1]. Distinct from the other leg-wheel hybrid mobile robots which are mostly having separated mechanism for wheels and legs or articulated wheels, this robot implements a transformation mechanism where each wheel of the robot can be directly transformed into two degree of freedom legs. The transformation mechanism is actually changing the wheels which are in around shape, into legs by breaking up the round wheel into two half circles and combining it as a leg. The robot in both legged and wheeled can be seen in Fig.13 below.

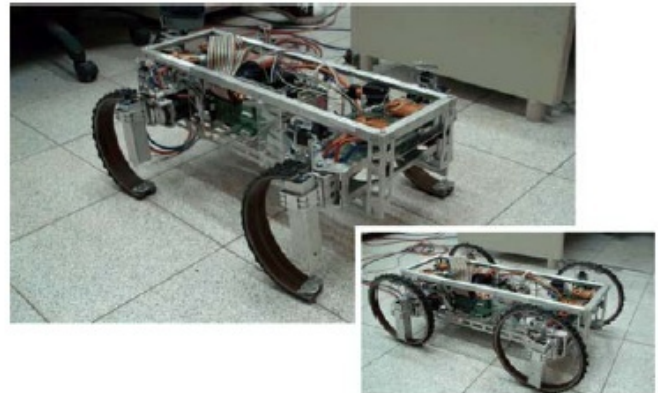

Fig. 13: The Leg-Wheel Hybrid Robot in Legged and Wheeled Mode (Used with permission from [1])

The crucial part in the design of this robot is the transformation mechanism which enables the robot to deform a particular part of the robot morphology to function as legs or wheels. A wheel normally consists of a rotary axis and a spherical rim where the rotary axis is situated at the middle of the spherical rim. A "hip" joint is the point where the rotary axis links with the mobile platform. In wheeled locomotion, the point of the hip is fixed where the distance from the hip to the touching point with ground is the radius of the circular rim. However in legged locomotion, the connection between the hip and the touching point with ground is not confined. Therefore, the locomotion can be switched from wheeled mode to legged mode by moving the hip point out from the middle of the rim.

As we can see in Fig.13, the robot was built up with four wheels. In wheeled mode, the locomotion mechanism of the robot is similar to a 4-wheel-drive vehicle. The robot can be moved forward or backward when rotation motions are activated at the hip joints. The turning motion of the robot is achieved by steering the front wheels according to Ackermann steering geometry.

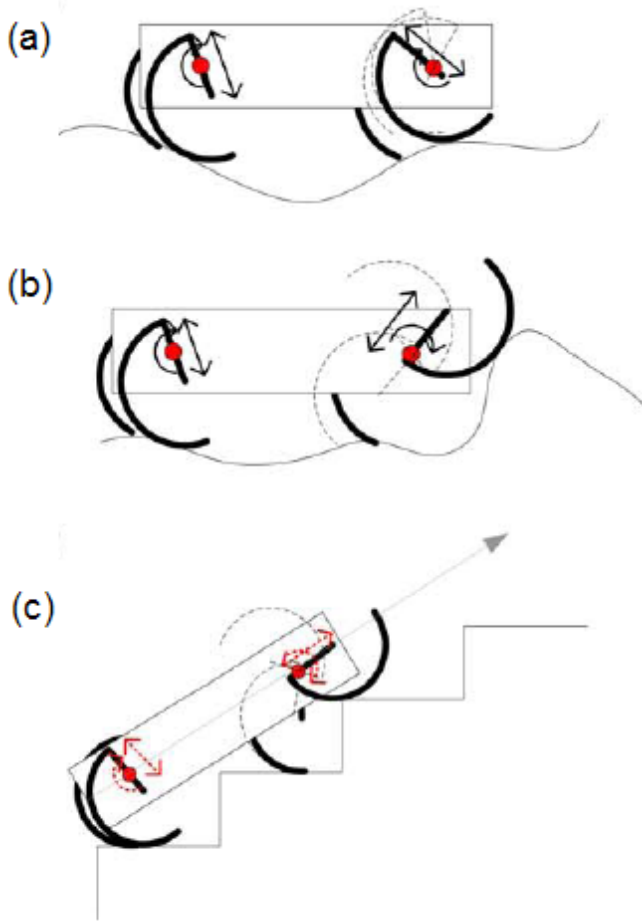

Fig. 14: leg mode locomotion (a) walking on rough terrain; (b) climbing across obstacles; (c) climbing stair ascent (Used with permission from [1])

In legged mode, the hip point is shifted closer to the rim after the rim of the robot is folded in half. The robot is then turned into a four-legged robot as illustrated in Fig.13. In legged mode, the robot is capable to traverse through rough terrain more smoothly than wheeled mode. Besides that, the robot is able to climb across large obstacles and also ascent or descent stairs. The leg mode locomotion on various terrains is shown in Fig.14.

4.3.2 Armadillo-Inspired Wheel-Leg Retractable Robot

The Department of Mechanical Engineering from Graduate School of Engineering, Osaka University proposed an improved hybrid wheeled-legged platform through a retracting structure inspired by the armadillo [3]. The robot is a Quattroped with four retractable legs which can be transformed into wheels. The proposed retractable mechanism comprises a large wheel diameter to realize a high ability on climbing obstacles.

The idea of the retractable wheeled-legged module is illustrated in Fig.15. The wheel contains all the joints of a leg; hence, it is able to achieve a larger diameter for climbing obstacles.

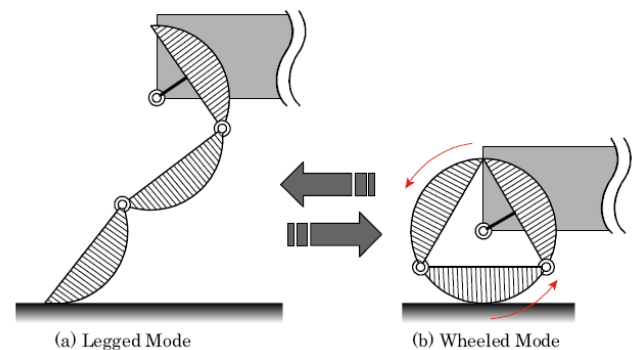

Fig. 15: Retractable Wheel-Leg Module (Used with permission from [3])

The proposed retractable wheeled-legged module enables the robot to have a better maneuverability. It is easier for the robot to climb small single-step and obstacles due to its large diameter of wheel when the robot is in wheeled mode. On the other hand, when in legged mode, the robot has the ability to choose the position of the foot end on uneven terrain by fully utilizing the small foot print of its leg. Fig.16 shows the prototype of the retractable wheel-leg hybrid robot.

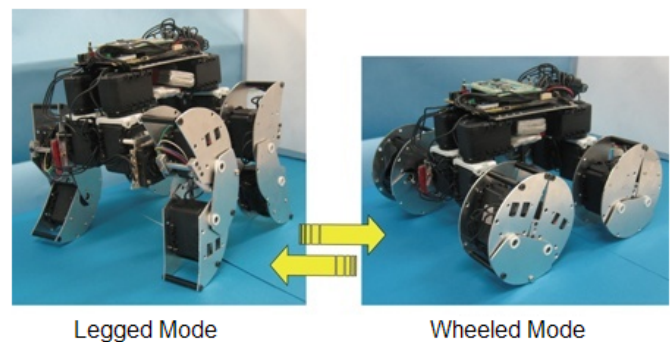

Fig. 16: The Prototype of the Retractable Wheel-Leg Hybrid Robot (Used with permission from [3])

The retractable wheel-leg module enables the robot to have another application which is the rolling grasping motion. This module can act as gripper with some joints when it is on legged mode to perform grasping operation as shown in Fig.17(a). While on wheeled mode, this module can act as gripper with a large roller as illustrated in Fig.17(b).

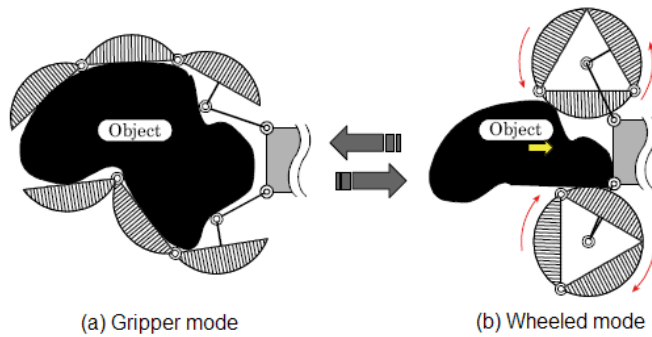

Fig. 17: Grasping Motion with Joints and Rolling (Used with permission from [3])

4.4 Summary

There are total of seven hybrid mobile robots that have been reviewed in the last section. The review is focused on the design of their locomotion mechanisms and is categorized in three categories, which are leg with wheel at the end (articulated-wheel), independent leg and wheel modules and reconfigurable or transformable wheel mechanisms. A summary of the structure and features of the reviewed robots is listed in table 1 (Appendix).

5 CONCLUSION AND WAY FORWARD

This paper classifies mobile robots into three categories which are wheeled robots, legged robots and hybrid mobile robots. For hybrid mobile robots, there are three common types of locomotion mechanism: legs with wheels at the end (articulated wheel), independent leg and wheel modules, and reconfigurable or transformable wheel modules. The main part of this paper is to present a survey on recently developed hybrid mobile robots by inspecting their design concepts and control methodology. Apart from that, this paper also presents a discussion on the factors that influence the design of a robust robotic platform which are the important criteria in designing a hybrid mobile robot.

As has been reviewed, numerous hybrid mobile robots have been proposed and developed. However, as far as we are aware, most of the hybrid mo-

ble robots are manually designed where the designers must have the preliminary knowledge of the interaction between the robots with the environment. The use of artificial evolution for the automatic generation and synthesis of controllers and/or morphologies for robots is one of the more recent methods in developing robots [17][18][19]. By implementing evolutionary algorithms in designing a robot, an optimized controller and/or morphology can be obtained where at times, these evolved solutions might be beyond the designers' design capability.

A co-evolution approach to sensor placement and control design for robot obstacle avoidance has been proposed by Wang and others [20]. Obstacle avoidance can be considered as one of the most important features of an autonomous mobile robot. Previously, numerous obstacle avoidance approaches were based on a specific robot hardware design and subsequently experimented with to obtain the optimal controller design. The sensor placement for the robot is based on the designers' experience or common sense which is hard to determine as optimal. By looking into natural system, we can find animals that co-evolved their sensor systems (physical sensory attributes) together with their control (neural) systems when they were trying to adapt to the environment. Thus, a co-evolutionary approach would appear to be highly beneficial as well in the case of designing hybrid robots. The selection and placement of sensors in addition to the design of a suitably integrated control system for hybrid robot morphologies, which arguably are more complex and complicated than conventional wheeled or legged robots, could be co-evolved in this case.

Similarly, simulated robots (creatures) had been successfully evolved by evolving both of their morphologies and controllers [21]. The evolved robots have the capability to traverse on flat and rough terrains. The robots are evolved through a developmental process which takes place in time and space. During the process, the robots are achieved through a progressive addition of both regulatory substances and structural parts. The robots were built up with distributed control systems. With a few independent neural controllers that are embedded in different parts of the robot which can only access the local sensory information, these will respectively form the overall control system. Analysis showed that the performances of the evolved robots were improved with respect to their capability to move on a flat terrain by increasing the complexity of the environment in which the robots were being simulated in. Again, such an approach to designing hybrid mobile robots could be benefit from such an evolutionary methodology. Independent neural controllers could be evolved or co-evolved to function within each individual articulated portion of the

hybrid mobile robot's morphology.

However, there is a critical issue in evolutionary robotics where very often robots that are evolved in simulations are inefficient when transferring to the real world. This transfer problem is called reality gap [22] which is the main cause that are hindering the use of evolutionary robotics for practical robotic applications. Koos and others recently highlighted that there is a conflict between the efficiency of the solutions in simulation and their transferability from simulation to reality [23]. They hypothesized that the solutions with best efficiency in simulation usually utilize badly modeled phenomena in achieving high fitness scores. They proposed transferability approach, where a multi-objective formulation of evolutionary robotics is utilized where two main objectives are optimized via a Pareto-based multi-objective evolutionary algorithm. The two main objectives are the fitness of solutions evolved in simulation and the transferability of the solutions to the real world. They have also suggested a simulation-to-reality (STR) disparity measure method to estimate the transferability objective. With the transferability approach, they have succeeded in finding efficient and good transferable controller within a very short duration of 10 experimental runs after transference onto the physical robot. Therefore, a multi-objective approach again could be considered in the case of evolving hybrid mobile robots in order to surmount this transference problem since an evolutionary approach to the design of such robots would require extensive simulation during the evolutionary optimization runs. Additionally, a multi-objective approach could be used not only to overcome the simulation-reality gap as a bi-objective problem but could also be extended to three and more objectives to include additional design criteria such as complexity, energy efficiency, and heterogeneity of morphologies.

Preliminary result of our first experiment in optimizing the morphology of a six legged-wheeled hybrid mobile robot shows that evolutionary algorithm can be implemented in designing robots [24]. In the experiment, the morphology of a six legged-wheeled hybrid mobile robot is evolved with single-objective evolutionary algorithm. The evolving parameters are the radius of wheels, length of legs, and size of body which are to be optimized in the evolution in order to produce a smaller robot with the ability to perform obstacle climbing motion. After the evolution simulation, the fittest robot is transferred into real world with 3D printing fabrication. Fig.18 shows the fittest robot in simulation and Fig.19 shows the fabricated robot. Further investigation on the evolution with multi-objective evolutionary algorithm and evolution involving more parameters will be carried out.

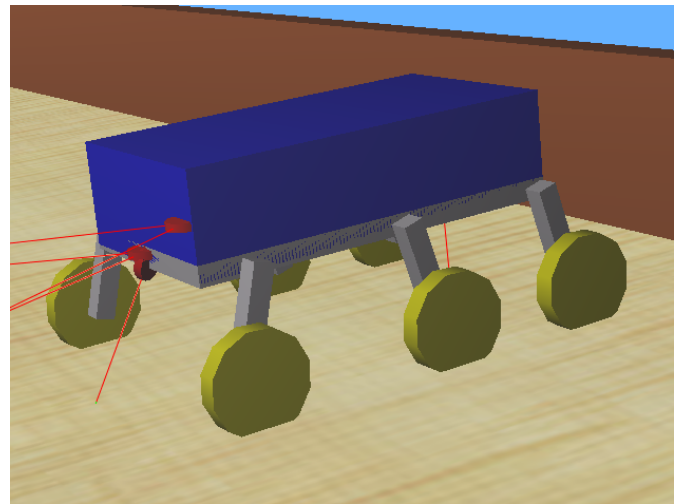

Fig. 18: Fittest Robot Obtained from the Evolution Simulation

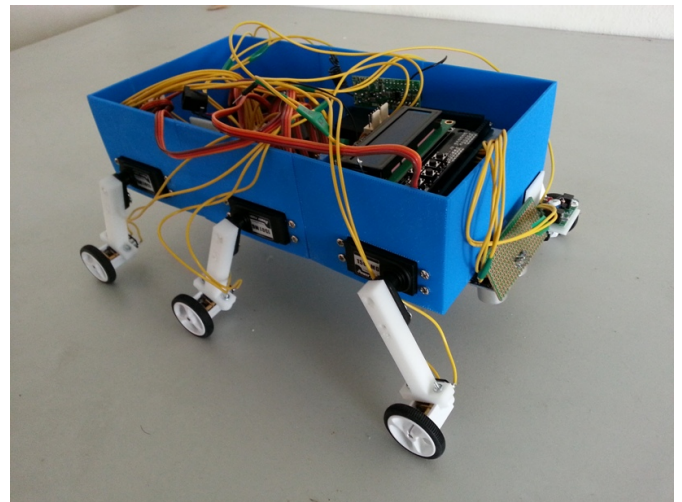

Fig. 19: Fabricated Robot with 3D Printing Technology

In conclusion, evolutionary robotics have been showing a great success and getting more and more attention among developers in robotics field. The possibility to develop undiscovered potential of evolutionary robotics is ultimately high and therefore more effort needs to be contributed on this field for robotics revolution.

Acknowledgements: This work was funded under ScienceFund project SCF0085-ICT-2012 granted by the Ministry of Science, Technology and Innovation, Malaysia

Table 1: Summary of the structure and features of reviewed robots

| Category | Robot(Developer) | Structure | Features |
|---|--|--|---|
| Leg with wheel at the end/articulated wheel mechanism | PAW, Platform for Ambulating Wheels (Centre of Intelligent Machine from McGill University) [4] [14] | <ul style="list-style-type: none"> - A quadrupedal. - Each leg houses a pair of extension strings and attached with actuated hard rubber wheel. | <ul style="list-style-type: none"> - Two operating modes which are wheeled (primary) and legged mode. - Capable of turning, braking and bounding movements. |
| | Six leg-wheeled robot (Graduate University of Chinese Academy of Sciences) [16] | <ul style="list-style-type: none"> - Six leg-wheeled robot - 12 individual motors for driving six legs and six wheels - Passive suspensions are installed at each leg for collecting information of the contact state between wheels and terrain. | <ul style="list-style-type: none"> - In-situ reconfiguration ability to adapt uneven terrain. - Obstacle negotiation ability whether to bypass obstacle or climb over obstacle. |
| | WheeHy (Institute of Computer Engineering from University Lubeck germany) [5] | <ul style="list-style-type: none"> - Three legged wheel-legged robot. - Designed with star shaped wheels which can be replaced with other types of wheel if required. | <ul style="list-style-type: none"> - Able to maintain a parallel position of the robot body while crossing uneven terrain with balancing strategy. - In-situ reconfiguration ability enables it to reconfigure itself after tipping over. |
| Independent leg and wheel mechanism | Bio-inspired legged-wheeled robot (Mechanical Engineering Department of King Mongkut's University) [13] | <ul style="list-style-type: none"> - Designed with two front legs with two degrees of freedom and 2 passive rear wheels. - The design of front legs is inspired by the kinematics of insect's legs. | <ul style="list-style-type: none"> - Robot movement propelled by swinging the two front legs that pushed the passive wheels to go forward and backward. - Able to navigate over rough terrain with large obstacles with faster speed and less energy. |
| | Wheeleg (DEES Robotic Laboratory of University of Catania) [12] | <ul style="list-style-type: none"> - Two individual rear wheels driven by two motors and two pneumatically actuated front legs with three degrees of freedom. - Two digital valves are joined with pneumatic cylinder of each leg where one for air inlet and one for air outlet. | <ul style="list-style-type: none"> - The design of Wheeleg is a beneficial solution for operation in a simpler environment where legged robots are not required but at the same time a better surface gripping is preferable. - A more complicated control system is required in order to drive the wheels and legs simultaneously. |
| Reconfigurable/transformable wheel mechanism | Transformable leg-wheel robot (Department of Mechanical Engineering from National Taiwan University) [1] | <ul style="list-style-type: none"> - Four legged legged-wheeled hybrid platform. - Transformable wheels which can be transformed in legs and vice versa. - Wheels in a round shape are changed into legs by breaking up the round wheel into two half circles and combining it. | <ul style="list-style-type: none"> - In wheeled mode, the locomotion of the robot is similar as a four wheeled drive vehicle. - In legged mode, the robot is turned into a four legged robot and capable to traverse through rough terrain and climb obstacles and stairs. |
| | Retractable wheeled-robot (Department of Mechanical Engineering from Graduate School of Engineering, Osaka University) [3] | <ul style="list-style-type: none"> - Quattroped with four retractable legs which can be transformed into wheels. - Wheel with larger diameter as it contains all of the links of a leg and by bending the direction of the joint in reverse direction can transform it into a leg. | <ul style="list-style-type: none"> - In wheeled mode, it is easier to overcome small single-step and obstacles with its larger wheels. - In legged mode, the small footprint of the robot leg enables it to choose the position of the foot end on uneven terrain. - Additional application which is the rolling grasping motion with its retraction module. |

References:

- [1] S. Y. Shen, C. H. Li, C. C. Cheng, J. C. Lu, S. F. Wang, P. C. Lin, Design of a Leg-Wheel Hybrid Mobile Platform, IEEE International Conference on Intelligent Robots and Systems(2009).
- [2] D. Angela, Urban Search and Rescue Robots: From Tragedy to Technology, IEEE,(2002).
- [3] K. Tadakuma, R. Tadakuma, A. Maruyama, E. Rohmer, K. Nagatani, K. Yoshida, A. Ming, S. Makoto, M. Higashimori, M. Kaneko, Armadillo-Inspired Wheel-Leg Retractable Module, IEEE International Conference on Robotics and Biomimetics,(2009).
- [4] A. S. James, S. Inna, T. Michael, PAW: a Hybrid Wheeled-Leg Robot, IEEE International Conference on Robotics and Automation,(2006).
- [5] J. Bojan, H. Martin, K. Michael, M. Erik, Design of a hybrid wheeled-legged robot - WheeHy, IEEE,(2010).
- [6] C. H. Ong, H.M. Shamsudin, Amin, A Biologically Inspired Hybrid Three Legged Mobile Robot, IEEE,(2002).
- [7] C. Gianni, O. Erika, Design and Simulation of a New Hybrid Mobile Robot for Overpassing Obstacle, Springer Science+Business Media B.V.,(2009).
- [8] G. Endo, S. Hirose, Study on Roller-Walker, IEEE International Conference on Robotics and Automation, vol. 1, 2032-237, (1999).
- [9] J. Yuan, S. Hirose, Research on leg-wheel hybrid stairclimbing robot, zero carrier, IEEE International Conference on Robotics and Biomimetics, vol. 1, 654-659, (2004).
- [10] C. Grand, F. Benamar, F. Plumet, P. Bidaud, Stability and traction optimization of a reconfigurable wheel-legged robot, The International Journal of Robotics Research, 1041-1058, (2004).
- [11] S. Nakajima, E. Nakano, T. Takahashi, Motion control technique for practical use of a leg-wheel robot on unknown outdoor rough, IEEE/RSJ International Conference on Intelligent Robots and Systems, vol. 1, 1353-1358, (2004).
- [12] M. Lacagnina, G. Muscato, R. Sinatra, Kinematics, dynamics and control of a hybrid robot wheelleg, Robotics and Autonomous Systems, 161-180, (2003).
- [13] S. Kawee, L. Sathaporn, A Bio-Inspired Hybrid Leg-Wheel Robot, IEEE, (2004).
- [14] A. S. James, S. Inna, T. Michael, Bounding Gait in a Hybrid Wheel-Leg Robot, IEEE International Conference on Intelligent Robots and Systems, (2006).
- [15] I. Poulakakis, J. A. Smith, M. Buehler, Modeling and Experiments of Untethered Quadrupedal Running With a Bounding Gait: The Scout II Robot, International Journal of Robotics Research, 24, 239-256, (2005).
- [16] J. L. Lu, C. G. Bu, Study on the Mobile Robot Reconfiguration Control Methods, Proceedings of the IEEE International Conference on Automation and Logistics, (2009).
- [17] L. Wang, K. C. Tan, C. M. Chew, Evolutionary Robotics: From Algorithms to Implementations, World Scientific Publishing, (2006).
- [18] S. Nolfi, D. Floreano, Evolutionary Robotics, MIT Press, (2000).
- [19] H. Iba, Frontiers in Evolutionary Robotics, I-Tech Education and Publishing, (2008).
- [20] W. C. Wang, S. X. Yang, W. R. Shi, M. Q. H. Meng, A Co-Evolution Approach to Sensor Placement and Controller Design for Robot Obstacle Avoidance, Proceedings of 2004 International Conference on Information Acquisition, (2004).
- [21] M. Mazzapioda, A. Cangelosi, S. Nolfi, Evolving Morphology and Controller: A Distributed Approach, IEEE Congress on Evolutionary Computation, (2009).
- [22] N. Jakobi, P. Husbands, I. Harvey, Noise and the Reality Gap: The use of Simulation in Evolutionary Robotics, in Proc. ECAL, 704-720, (1995).
- [23] S. Koos, J.B. Mouret, S. Doncieux, The Transferability Approach: Crossing the Reality Gap in Evolutionary Robotics, IEEE Transactions on Evolutionary Computation, VOL 17, No 1, (2013).
- [24] S.H. Lim, J. Teo, An Evolution Approach to Optimize the Morphology of a Six Legged-Wheeled Hybrid Mobile Robot, International Conference on Computational Science and Technology, (2014).
- [25] K.O. Chin, J. Teo, Artificial Neural Controller Synthesis in Autonomous Mobile Cognition, International Journal of Computer Science, 36(4):240-252 (2009).
- [26] K.O. Chin, J. Teo, Evolution of RF-Signal Cognition for Wheeled Mobile Robots using Pareto Multi-objective Optimization, International Journal of Hybrid Information Technology, 2(1):43-56, (2009).
- [27] A. M. Zak, O. A. Mahgoub, A. M. El-Shafei, A. M. Soliman, Design and implementation of efficient intelligent robotic gripper, WSEAS Transactions on Systems, 9(11), 1130-1142, (2010).

- [28] G. Tont, L. Vldreanu, M. S. Munteanu, D. G. Tont, Markov approach of adaptive task assignment for robotic system in non-stationary environments, WSEAS Transactions on Systems, 9(3), 273-282, (2010).
- [29] W. Jatmiko, A. Nugraha, R. Effendi, W. Pambuko, R. Mardian, K. Sekiyama, T. Fukuda, Localizing multiple odor sources in a dynamic environment based on modified niche particle swarm optimization with flow of wind, WSEAS Transactions on Systems, 8(11), 1187-1196, (2009).
- [30] S. Staines A., F. Neri, A Matrix Transition Oriented Net for Modeling Distributed Complex Computer and Communication Systems, WSEAS Transactions on Systems, 13, WSEAS Press (Athens, Greece), 12-22, (2014).
- [31] M. Camilleri, F. Neri, M. Papoutsidakis, An Algorithmic Approach to Parameter Selection in Machine Learning using Meta-Optimization Techniques, WSEAS Transactions on Systems, 13, WSEAS Press (Athens, Greece), 202-213, (2014).
- [32] M. Papoutsidakis, D. Piromalis, F. Neri, M. Camilleri, Intelligent Algorithms Based on Data Processing for Modular Robotic Vehicles Control, WSEAS Transactions on Systems, 13, WSEAS Press (Athens, Greece), 242-251, (2014).